

Fig. 1 Anatomy of the BOB Revolution Stroller.

BOB is a company that produces high quality products, which encourage a healthy, outdoor, car-free life-style. In addition to strollers, we also make single-wheeled cargo trailers for bicycles. See www.bobgear.com for our complete line of products. **Before attempting to assemble or use your new stroller, read and understand these operating instructions completely to insure proper assembly and operation.** If you are unclear on any point, contact your dealer or BOB before use.

▲ WARNINGS ▲

- Never leave child unattended in the stroller.
- Failure to properly assemble or install the quick release wheels on this stroller may result in the wheels becoming detached while moving and a subsequent loss of control of the stroller.
- Always use seat harness to avoid serious injury to child from sliding or falling out of stroller.
- Never allow occupants to stand in stroller.
- The parking brake is not designed as a stopping brake. The brake should not be used to slow or stop the stroller. The brake is intended to park the stroller on flat surfaces, not on inclines. Never leave your children in the stroller unattended with or without the parking brake set!
- Do not attach parcels or bags to the handle or frame of stroller except those recommended by BOB, as stroller can become unstable and tip over.
- The maximum load of the stroller is 70 lbs (32 kg). Do not exceed maximum load (occupant plus luggage weight) as stroller will become unstable.
- Do not place sharp objects in the seatback pocket as your child leans against this and can be injured as a result.
- When starting out, always make sure the child's hands and feet are away from wheels.
- Follow instructions and use care when folding and unfolding stroller to prevent finger entrapment (see section 13).
- The stroller is not equipped for use after dark. If you intend to use at night, we recommend installing a lighting system available through your local bike shop.
- We do not recommend wearing roller skates or in-line skates while pushing stroller.
- Never run with the stroller in Swivel Mode (see section 6)
- Do not use stroller on stairs or steep inclines. Stroller can tip over, resulting in injury.
- Never pull a loaded stroller backwards up stairs. Doing so could damage the suspension system – leading to frame failure and serious injury to the user and/or the occupants.
- Always use Wrist Safety Strap.

BOB IS NOT RESPONSIBLE FOR INJURY, DAMAGE, OR FAILURE THAT RESULTS FROM OWNER'S FAULTY ASSEMBLY OR MAINTENANCE AFTER SHIPPING.

AGE RECOMMENDATIONS:

It is recommended that your child be a minimum of 6 to 8 weeks old before riding directly in the stroller seat. Young babies incapable of holding their head up must be provided additional head and neck support to ride safely. For jogging and off road use, children should be at least 6 to 8 months old.

Children develop at different rates. Consult with your pediatrician regarding the suitability of the stroller use with your child.

ASSEMBLY INSTRUCTIONS:

Reference Fig. 1 as it describes the various parts of the stroller.

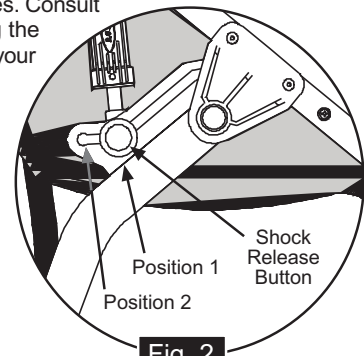

Fig. 2 Swingarm in unfolded position with shock in position 1.

1. UNPACK: Remove stroller and stroller wheels from packaging. Plastic packaging material was used to protect the front fork dropouts, the front wheel axle quick release, handlebar release levers and the metal shock brackets. Remove these plastic pieces.

2. SWINGARM: Rotate the swingarm away from the front of the stroller until the shocks engage in the first position (Fig. 2). Each shock locking pin will "snap" and lock into position 1.

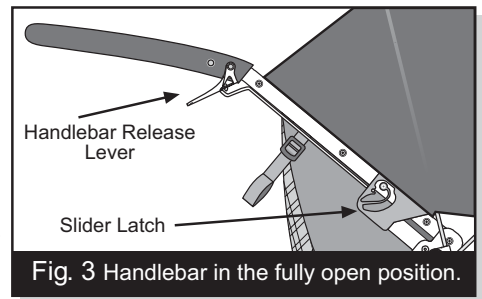

Fig. 3 Handlebar in the fully open position.

3. HANDLEBAR: Rotate the stroller handlebar up to the fully open position. Slider Latches will lock into place (Fig. 3).

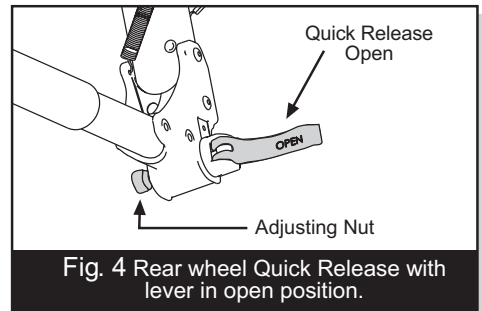

Fig. 4 Rear wheel Quick Release with lever in open position.

4. REAR WHEEL: Place the rear wheel quick release lever in the open position, as shown in Fig. 4. Insert the rear wheel's stub axle into the hole in the rear dropout. If the axle does not slide in easily, loosen the quick



release adjusting nut (Fig. 4) by hand. Re-insert the axle fully into the rear dropout until the axle shoulder or snap ring on the axle comes in contact with the dropout (Fig. 5).

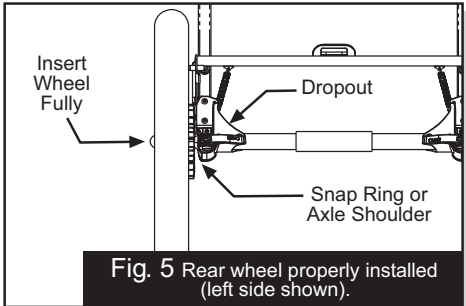

Fig. 5 Rear wheel properly installed (left side shown).

Move the quick release lever to the closed position (Fig. 6). The word CLOSE should be clearly visible and the quick release lever should almost touch the dropout. When properly adjusted, it will require considerable torque (80-105 in-lbs or 9-12 Nm) to close the lever. If you do not feel this resistance (too loose or too tight), return the quick release lever back to the open position (Fig. 4), and adjust the adjusting nut (clockwise to tighten, counterclockwise to loosen). Move the quick release lever to the closed position (Fig. 6).

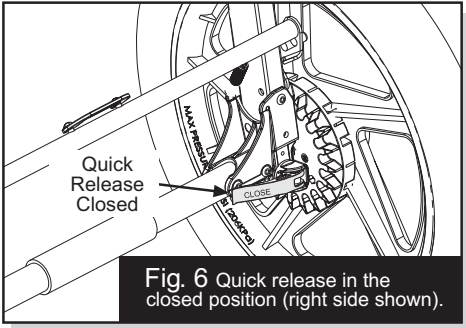

Fig. 6 Quick release in the closed position (right side shown).

NOTE: Follow all instructions exactly. If you are unsure how to operate the quick release, consult your dealer or contact BOB.

5. FRONT WHEEL: (Fig. 7)

shows the anatomy of the front wheel and quick release. The front fork's dropouts are slotted to receive the front wheel (Fig. 8). Slide the wheel into the dropouts so that the quick release lever is on the left hand side of the stroller when the fork is rotated forward and locked in Jog Mode (see section 6). Make sure the wheel is centered in the fork and that the axle is touching the top of the drop out slot. Securely tighten the wheel in place as follows: With the quick release lever in the open position (Fig. 8), tighten the adjusting nut (clockwise) until it comes in contact with the dropout. Move the quick release lever to the closed position (Fig. 9). This should require significant pressure. If you do not feel significant resistance, turn the quick release lever back to the open position (Fig. 8), and hand tighten the adjusting nut one or two turns in the clockwise direction until snug. Move the quick release lever toward the closed position (Fig. 9). The word CLOSE should be clearly visible and the quick release lever should be parallel to the stroller fork leg. It should require

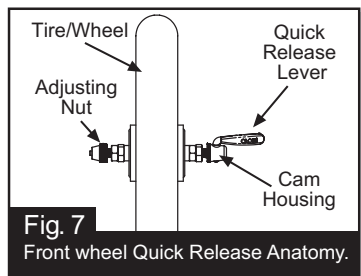

Fig. 7 Front wheel Quick Release Anatomy.

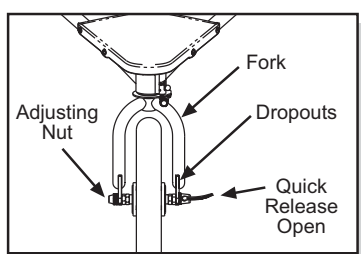

Fig. 8 Front fork dropouts shown with wheel in position. Adjust nut snug with Quick Release in open position.

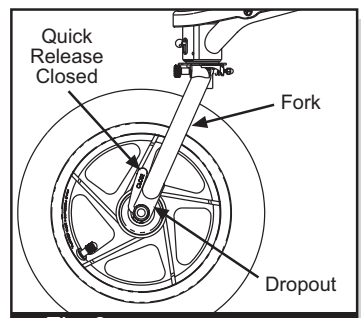

Fig. 9 Quick Release in closed position and parallel to fork leg.

considerable torque (80-105 in-lbs or 9-12 Nm) to close the lever when properly adjusted. to properly adjust quick release may result in wheel loss and serious personal injury. If you are unsure how to operate the quick release, consult your dealer or call BOB.

6. SWIVEL LOCKOUT: The Revolution Stroller can be used in one of two modes. The stroller can be used as a swiveling wheel stroller (Swivel Mode) when the Lockout Knob is in the unlocked position (Fig. 10). Or, it can be used as a fixed wheel stroller (Jog Mode) when the swivel Lockout Knob is in the locked position (Fig. 11). To change from Swivel Mode to Jog Mode, lift and slide the Lockout Knob (Fig. 10) up and all the way to the right. Then release the knob, and it will snap down. Next, rotate the fork until the pin engages and locks the fork in position. You are now ready to use the stroller in Jog Mode. To change the stroller back to Swivel Mode, lift the Lockout Knob and rotate it to the left.

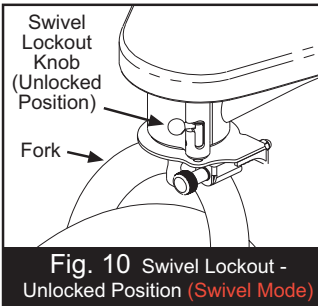

Fig. 10 Swivel Lockout - Unlocked Position (Swivel Mode)

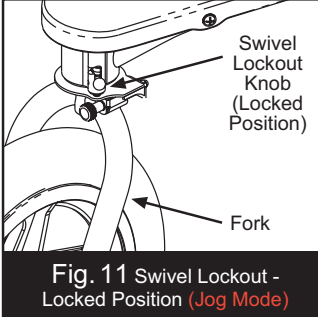

Fig. 11 Swivel Lockout - Locked Position (Jog Mode)

7. TRACKING ADJUSTMENT:

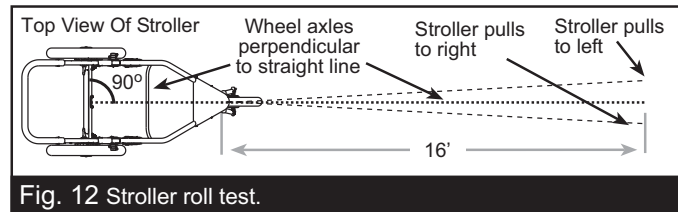

Fig. 12 Stroller roll test.

It should be noted that all fixed three wheeled vehicles can be easily influenced to deviate from a straight path. In some cases strollers can have or develop a tendency to pull to the right/left due to many different factors including tire pressure, wheel installation, road conditions and manufacturing tolerances. If you find your BOB stroller to significantly track or pull to the left or right while in Jog Mode during use on flat terrain, follow the sequence of instructions below.

TRACKING ADJUSTMENT INSTRUCTIONS:

- Note: Tracking adjustment can only be performed with the stroller fork locked out (Jog Mode). Roll test the stroller as described below. It is recommended you have someone assist with this task in order to catch and return the stroller. Fig. 12 illustrates the roll test process.*
- Empty the stroller. **Do not roll test with a child or any occupant in the stroller.**
 - Find a location on level ground approximately 16 ft. long. It is helpful to use an existing straight-line as a frame of reference such as the edge of the sidewalk or a painted line in a playground.
 - Align the stroller so the rear wheel axles are perpendicular to the straight line. Push and release the stroller, trying carefully not to influence its direction to the left or right, so it rolls straight down the test path. This step should be performed more than once to make sure the stroller was not biased left or right by the pushing action.
 - If the stroller consistently pulls to the left or right when pushed straight, proceed with the steps

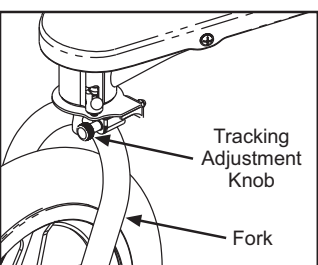

Fig. 13 Tracking Adjustment.



below until tracking is satisfactory. Fig. 12 illustrates how to interpret the results.

Reference convention: Left and right are described as viewed from the operator's frame of reference (behind the stroller). Example: The swivel lockout knob is on the left side of the stroller.

Fine tune tracking of stroller is accomplished by using the tracking adjustment knob shown in Fig. 13. If your stroller pulls to the left, turn the knob counter-clockwise 1/2 turn.

If your stroller pulls to the right, turn the knob clockwise 1/2 turn. Repeat Roll test and adjustment until the stroller rolls straight.

8. PARKING BRAKE:

THE BRAKE: The brake is a parking brake, it prevents the stroller from moving while loading and unloading. The parking brake is not designed as a stopping brake. Do not use the brake to slow or stop the stroller. The brake is intended to park the stroller on flat surfaces, not on inclines. Never leave your child in the stroller unattended with or without the parking brake set!

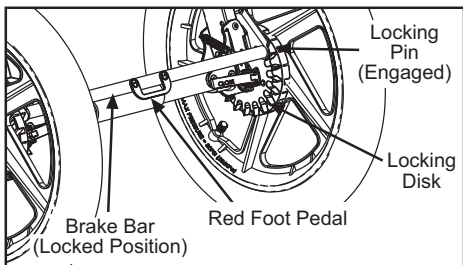

Fig. 14 Parking Brake - Locked position.

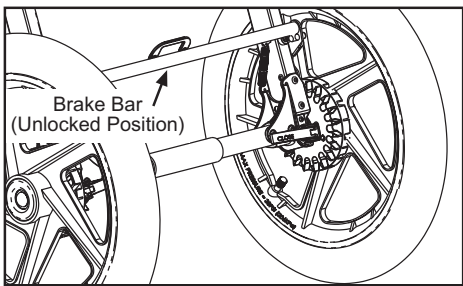

Fig. 15 Parking Brake - Unlocked position.

To set the parking brake, press the brake bar down into the locked position (Fig. 14) with your foot on the red foot pedal – making sure the locking pin fully engages the locking disk. To ensure the brake is set properly, attempt to roll the stroller fore and aft after setting the brake. If the stroller will not roll, the brake is set properly. To release the parking brake, lift up on the red foot pedal with your foot until the brake bar springs up into the fully unlocked position (Fig. 15).

9. SUN CANOPY:

The stroller features a two position canopy. To fully open the canopy, rotate the assembly forward until the fabric is taut. The rear canopy flap should be freed from the Velcro to give additional sun protection. To reduce the size of the sun canopy, pull the canopy toward the handlebar. The additional fabric can be gathered by pulling the canopy drawstring (Fig. 1) and securing the cord lock.

10. SEAT SAFETY HARNESS:

Set parking brake before placing child in stroller. To secure your child in the seat, put one shoulder strap over each shoulder and snap the male buckle into the female receiver on the crotch strap (Fig. 16). Adjust shoulder straps to be snug and secure (Fig. 17). Connect and adjust the sternum strap (red), see Fig. 18.

WARNING: Never place passengers in the stroller without securing them in the harness. Unrestrained passengers can affect the control

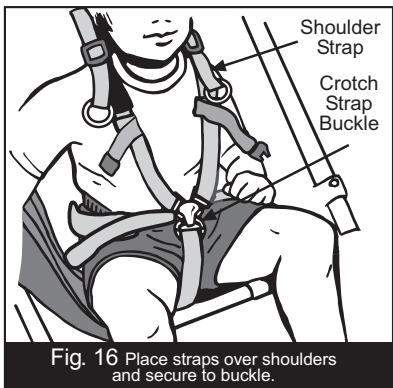

Fig. 16 Place straps over shoulders and secure to buckle.

of the stroller.
Passenger weight limit - 70 lbs (32 kg)
Passenger height limit - 44 in (112 cm)

11. RECLINING SEAT:

Set parking brake before making any seat adjustments. To recline the seat, rotate the ladder lock buckles (Fig. 19) forward thus releasing the reclining straps. To raise the seat, pull the reclining strap loops until you obtain the desired position. The seat back can be adjusted to recline anywhere between the fully upright position and the fully reclined position (Fig. 19 & 20).

12. SHOCK ABSORBERS:

The suspension system features two shock positions to provide a comfortable ride for kids of different weights. The two positions are shown in Fig. 2. Position 1 is intended for occupants up to 40 lbs. (18 kg), while position 2 is intended for occupants from 40 to 70 lbs. (18 to 32 kg) total. The stroller features a metal shock bracket with a sliding track and spring loaded shock pin that automatically locks in place when it aligns with either of the two shock positions. Shock position adjustments should be made with the stroller unloaded. The shocks will lock into position 1 when unfolding the stroller. To use the stiffer shock position, move the shock from position 1 to position 2 by depressing the shock release button (Fig. 2) with one hand, and with the other hand, lift slightly and pull the shock backward. When the shock pin is properly aligned in position 2, the pin will "snap" into place. Repeat this process for the second shock. To move the shock from position 2 to position 1, reverse the above process for both shocks.

13. FOLDING:

Remove child from stroller. Remove the contents of the Low Boy cargo pouch, seat back and seat pockets. The shock absorbers must be in position 1 (Fig. 2) before folding. Press both the right and left handlebar release levers (Fig. 3), and fold the handlebar forward as shown in Fig. 21. Locate the frame release handle underneath the seat (Fig. 22) and pull upwards sharply. This will allow the lower frame to fold together, as shown in Fig. 23. The folded stroller can be made even more compact by removing the front and rear wheels. The front wheel is removed by opening the front wheel quick release and removing the wheel

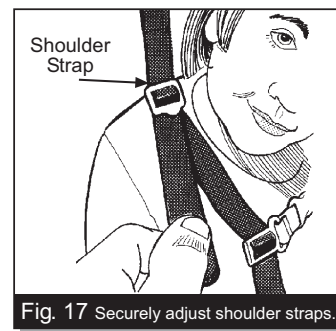

Fig. 17 Securely adjust shoulder straps.

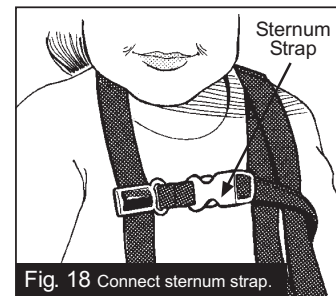

Fig. 18 Connect sternum strap.

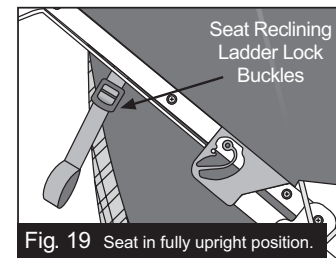

Fig. 19 Seat in fully upright position.

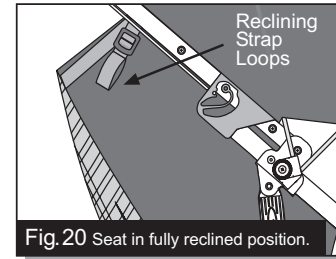

Fig. 20 Seat in fully reclined position.

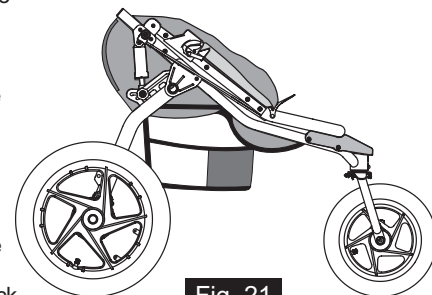

Fig. 21

Stroller with handlebar folded.



(see section 5). The rear wheels are removed by releasing the parking brake (See section 8), and then opening the rear wheel quick release (Fig. 4), and pulling each wheel directly to the side. The Wrist Safety Strap can be used to keep the stroller in the folded position for transport and storage. With the stroller folded, loop the end of the wrist safety strap around the handlebar and back to the cross tube and fix the Velcro surfaces together (Fig. 24).

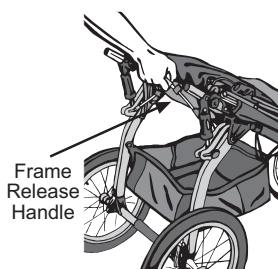

Fig. 22

Pull handle upwards sharply to fold.

14. TIRE PRESSURE:

IMPORTANT: Check tire pressure before every use. Keep all tires inflated to pressure specified on the rim (30 p.s.i.).

15. STROLLER CARE & MAINTENANCE:

The fabric is 100% polyester with a stain resistant treatment that makes cleanup easy. Use a sponge with a solution of mild soap and lukewarm water (maximum temperature of 100 deg. F / 38 deg. C). Rinse thoroughly with clean water to remove soap then air dry. Do not use detergent. Regular maintenance should include: Verifying tire pressure, verifying that all screws and fasteners are tight, and wiping parts clean with a rag. To reduce the possibility of squeaks, periodically apply a small amount of lubricant (Triflow, 3-in-one, or light sewing machine oil) to the pivot axles and interior faces of the pivot brackets, as shown in Fig. 25.

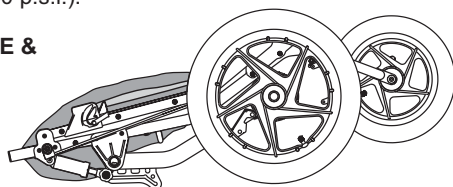

Fig. 23

Stroller in fully folded position.

STORAGE: It is best to store your stroller indoors when it is not in use. This will prolong its attractive appearance. Extended exposure to the sun's ultraviolet rays can fade and damage the fabric, tires, and plastic parts.

CARGO: The stroller is equipped with two small seat pockets for your child, a seatback pocket and a Low Boy cargo pouch under the stroller. Adding weight to the seatback changes the center of gravity of the stroller, and

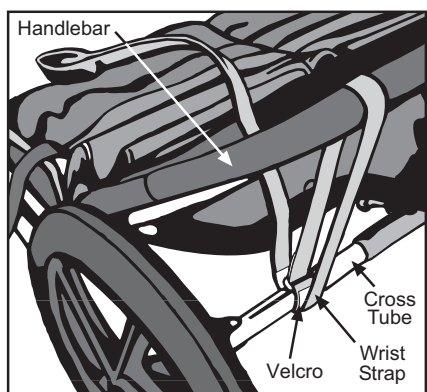
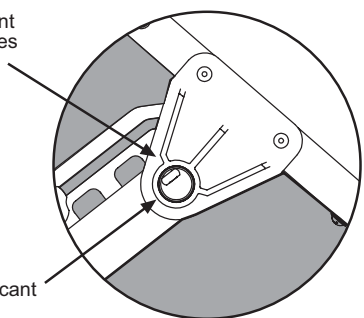

Fig. 24 Secure stroller in folded position.

Apply Lubricant to Interior Faces of Bracket



Apply Lubricant to Axle

Fig. 25

Lubrication Points

increases the possibility that it will tip over backwards. For this reason, loads in the seatback pocket should never exceed two pounds (1 kg.). Although the seatback is padded, it is important to remember that this is what your child leans against. Never place sharp or injurious objects into the seatback pocket. Maximum load for Low Boy is 10 lbs (4.5 kg).

LIMITED WARRANTY

BOB Trailers Inc. takes pride in its workmanship and strives to manufacture the best products possible. Therefore, we warranty our Revolution Strollers against defects in material and workmanship subject to the conditions listed below. Since no product is indestructible, it does not cover defects attributable to or resulting from normal wear, abuse or alteration.

- Frame is warranted for 5 years.
- Components and fabric are warranted for one year.
- Warranty is only valid for the original purchaser.
- Proof of purchase is required to exercise this warranty.
- Labor and freight charges are not included.
- Normal wear, neglect, abuse, accidents, improper assembly or maintenance, or the installation of parts or accessories not compatible with the original intended use of the stroller, as sold, are not covered by this Warranty.
- Warranty claims must be made through an authorized dealer.
- This warranty is limited to the repair or replacement of the defective part. BOB shall in no event be responsible for consequential or special damages.
- This Limited Warranty is the only express or implied warranty applicable to BOB. Any implied warranties, including warranties of merchantability and fitness shall be limited in scope and duration in accordance with this limited warranty.

STROLLER ACCESSORIES

BOB offers a complete line of accessories for your Revolution stroller. Visit our website for full details, specs and images: www.bobgear.com

HANDLEBAR CONSOLE

At your finger tips storage for two water bottles or drinks and other small items. 4 Velcro straps for easy attachment.

WARM FUZZY

Warm Fuzzy Seat Insert -The ultimate in plushness & comfort. Thick, polypropylene fleece will give you and your child a warm fuzzy!

WEATHER SHIELD

Your little one will be dry & comfortable in bad weather, strolling with the BOB Weather Shield!

INFANT CAR SEAT ADAPTER

Allows quick attachment of leading brand infant car seats to your stroller so you don't have to wait to take your infant on a stroll with BOB! Once installed, easily folds with stroller.

SUN PROTECTOR

Reduces up to 65% of solar heat and glare as well as UVA/UVB rays. Also protects children from brisk winds and flying insects.