

COZ



YAK



B·O·B

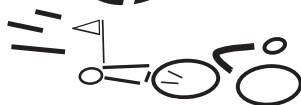

COZ



YAK



**OWNER'S
MANUAL**





Fig. 1 Anatomy of the COZ and YAK trailers.

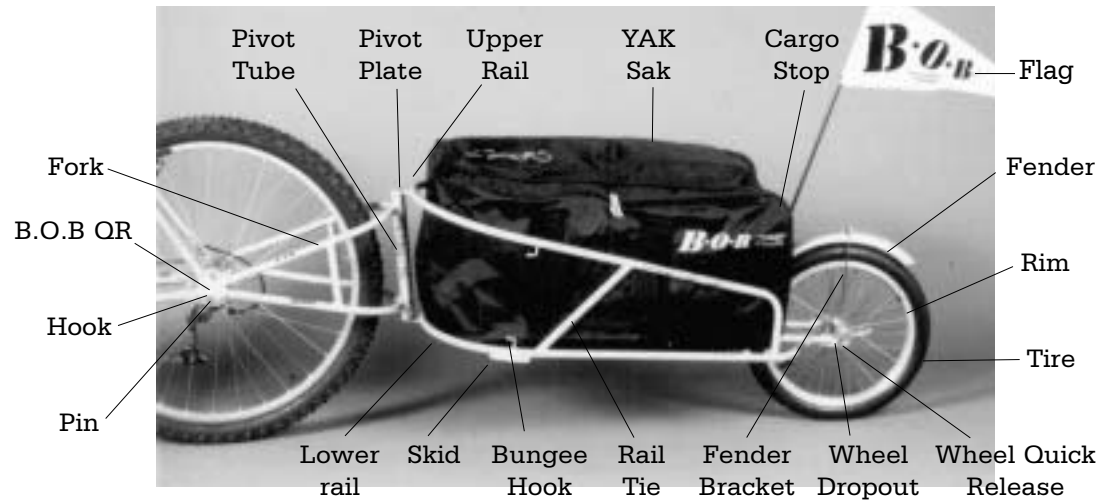
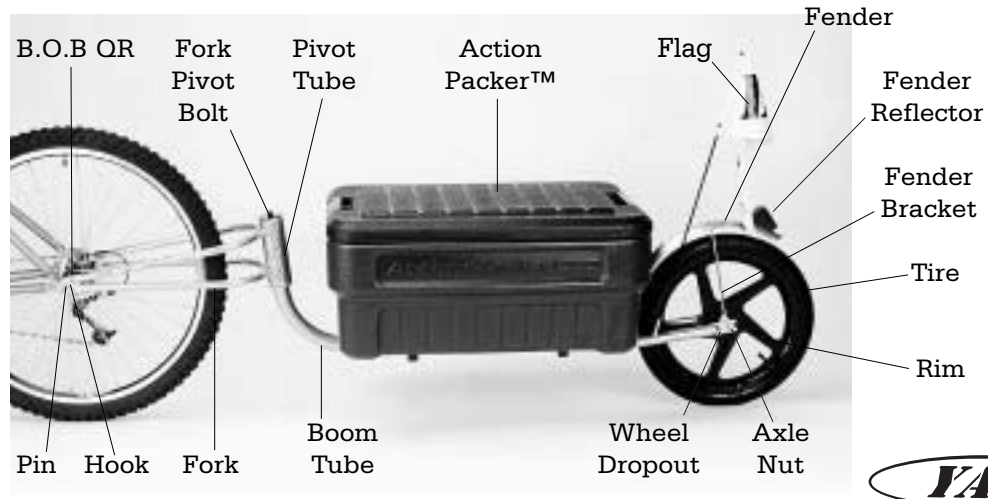

TABLE OF CONTENTS

GENERAL INTRODUCTION / TIPS FOR USE3

ASSEMBLY INSTRUCTIONS10

 main frame10

 fender assembly11

 wheel installation12

 B.O.B Quick Release Installation17

 trailer attachment21

MAINTENANCE25

WARRANTY29

ADDITIONAL B.O.B PRODUCTS30

SPECIFICATIONS32

2

PRE RIDE CHECK LIST

- 1. Check and tighten allen screws on the ends of the QR before installation.**
- 2. Check and tighten pivot allen screws on the COZ or YAK before initial use. These screws must be tightened against each other at the same time.**
- 3. Sandwich fender with washers when attaching it to the trailer with allen screw.**
- 4. Check rear derailleur clearance after trailer is attached before initial use.**



CONGRATULATIONS on being the new owner of a B.O.B trailer. We call it getting "B.O.B'd". You are part of a growing movement in the bicycle world embracing lightweight, hi-end, single wheel bicycle trailers. B.O.B is a company that is committed to developing quality products which encourage a healthy, outdoor, car-free lifestyle. We make single-wheeled cargo trailers, kid trailers, and strollers.

Before attempting to install or use your new trailer, read these operating instructions completely to insure proper assembly, installation, and operation. This manual covers assembly, use, and maintenance instructions for both the B.O.B COZ and YAK Bicycle Trailers. Many of the instructions are the same for both models. In such cases the COZ and YAK are referred to collectively as the "trailers". In some cases there are model specific differences. In cases of such differences, model specific instructions are provided and are so designated by model name. Thanks for getting B.O.B'd !!

3

IMPORTANT NOTICE

The trailers are designed to be attached to bicycles with wheel diameters between 20 and 28 inches (includes 700c). The dimensions of the tire appear as a raised surface on the side walls. They will typically appear similar to the following example: 26" x 1.9". The first number refers to the diameter and the second to the width. It is critical that your wheels meet the diameter specifications listed above. If they do not meet these specifications it is unsafe for you to attach the trailers. If you have questions about your wheel diameters or the compatibility of the trailers with your bicycle, consult your bicycle dealer.

QUICK RELEASE

The trailers attach to your bicycle by means of a specially designed quick release which inserts into the rear hub of your bike. If your bike does not have a rear quick release, the trailer will need to be attached with B.O.B Nutz. B.O.B Nutz are special adapters for bicycles with solid axles. They are made for axles with the following threading: 3/8 x 24 tpi, 3/8 x 26 tpi, 10 x 1, and 10.5 x 1 or 13/32 x 26 tpi (Sachs and Sturmey Archer Internal Gear Hubs - I.G.H.) See **Fig. 2**.

DROP OUT SPACING

For the B.O.B quick release to safely work with your bicycle, the overall dimension from outside to outside of your bike frame's rear wheel dropouts (overdrop dimension) must fall within the following range:

Minimum Width 140 mm Maximum Width 156 mm
The correct way to measure your overdrop dimension is

shown and explained in the B.O.B Quick Release Installation Section, item 2a., of the manual. If you are uncertain of how to correctly measure the rear dropout outside to outside dimension, or whether your bicycle is compatible with the trailers, consult your bicycle dealer.

RIDING AND SAFETY TIPS

Pulling a B.O.B Trailer

Although the trailers have been designed to have as little impact as possible on the handling and operation of your bicycle, there are several points you need to be aware of when pulling a trailer. The following information will familiarize you with the peculiarities of pulling a trailer.

FIG. 2 BOB NUTZ solid axle adapters for bikes with solid axle hubs (includes Internal Gear Hubs).



4

EXTREME ROTATION

In cases of extreme rotation of the trailer around the quick release BOBBIN, in the counter clockwise direction, it is possible for the fork to come in contact with the rear derailleur mount as shown in **Fig. 3**. This contact can cause damage to the derailleur mount, quick release, and retaining pins and adversely affect the attachment of the trailer, potentially resulting in the loss of control. It requires approximately 20 degrees of counter clockwise rotation for this condition to occur. This is beyond the intended scope of use.

FIG. 3 Trailer in extreme counter-clockwise rotation showing contact between derailleur pivot housing and trailer fork. AVOID this condition. If you believe this has occurred, inspect your derailleur, QR, and pins for damage. Note: reversing the installation of the QR (install from the drive side / right side of bike) helps eliminate this problem (**Fig. 5a**).



When the trailer is rotated in an extreme clockwise direction it is possible for the retaining pin on the derailleur side to come in contact with the derailleur mount as shown in **Fig. 4**. This contact can cause damage to the derailleur mount, quick release, and retaining pins, and adversely affect the attachment of the trailer, potentially resulting in the loss of control. It requires approximately 90 degrees of clockwise rotation for this condition to occur. This is beyond the intended scope of use.

Whenever using the trailer, whether pulling or moving it, be extremely careful to avoid these conditions. If you believe this condition has occurred you should inspect your derailleur, quick release, and pins to insure they are in good working order. If you have questions about this, consult your dealer.

FIG. 4 Trailer in extreme clockwise rotation showing contact between derailleur mount and retaining pin. AVOID this condition. If you believe this has occurred, inspect your derailleur, QR, and pins for damage



5

ATTACHMENT

Please refer to the Trailer Attachment section of the Owner's Manual for the correct installation of the quick release and trailer. It is imperative that both the quick release and trailer are installed correctly. Failure to do so can result in accidents and injury. If, after reading the instructions, you are uncertain about the correct operation of the quick release and trailer attachment, consult your bicycle dealer.

LENGTH AWARENESS

When towing the trailer, be very conscientious of the additional length you now have behind you! It can be very easy to forget that you have anything back there and cut someone off. Get a feel for the proportions of your trailer by having a friend ride your bike and trailer while you ride next to and behind them. Use the flag provided as it tells everyone (including cars) where you are and more importantly, how long you are. Please refer to the assembly section of the Owner's Manual for proper flag assembly and installation.

LOADING

It is very important that the trailer be loaded correctly to insure safe operation. These guidelines should be observed when loading:

Cargo Only - The trailers are designed as a cargo carrier. DO NOT CARRY HUMANS OR ANIMALS.

Cargo Weight Limit -

COZ: 50 POUNDS (23 KILOGRAMS)

YAK: 70 POUNDS (32 KILOGRAMS)

Be aware that the more weight you add to the trailer, the more effect it will have on the handling of your bicycle. When you start off with a load, get accustomed to how the load affects the handling of your bicycle and adjust your riding style accordingly.

Height Limit - The trailers are designed to keep the cargo's center of gravity as low as possible. When loading the trailer pay careful attention to keeping the load low as this will effect the center of gravity and the handling of the bicycle. The higher the load the greater the effect. With any new load, become accustomed to how the load effects the handling of your bicycle and adjust your riding style accordingly.

COZ Note: The load height should never exceed the height of the Action Packer box.

YAK Note: The load height should never exceed 18 inches (46cm) from the trailer platform.

Securing Cargo - When loading the trailer, it is important that all cargo be securely fastened as shifting loads may adversely effect bicycle handling and result in loss of control. Additionally, cargo should never overhang from the trailer. Also make certain there are no loose items such as bag straps which can become caught on passing objects or

6

the spokes of either the bicycle or trailer.

The YAK comes with a 4 way bungee cord to assist you in cargo retention. Depending on the nature of the load, it may be necessary to use additional bungee cords or other fasteners to properly secure your cargo.

BRAKING

Make sure your bike's brakes are in top condition and properly adjusted. Marginally performing brakes will be inadequate for safe braking with the added load of a trailer. Please refer to your bike's Owner's Manual or consult your dealer for proper brake adjustment.

Braking Distance - Stopping distances will be longer when pulling a trailer. Your bike must slow and stop the trailer, which has no brakes of its own. The more weight in the trailer, the longer the braking distance. Monitor your speed for the trail, road, traffic conditions; and the load you are carrying. Be especially careful to check your speed during descents. Account for the additional braking distance required to stop, and always use caution to maintain these braking distances. We recommend that you practice stopping your bike and trailer when first starting your ride to get a feel for the time, distance, and brake lever force required for making safe stops.

Wet Conditions - Most bicycles have a caliper braking system which uses the side wall of the rim as the braking surface. When it is wet, the sidewall becomes moist, reducing friction and stopping power, and increases braking distances. When riding in wet conditions use extreme caution and allow extra distance for braking.

VISIBILITY

Car drivers don't expect bicycles to be pulling trailers. Exercise additional caution to make sure you are seen. Assume the trailer cannot be seen by motorists and other traffic and adjust your riding style accordingly. When crossing intersections, remember that your overall length has increased. Allow additional time to safely cross. **REMEMBER:** the trailer is lower than you and your bike, and may be obscured from motorist's vision. The trailers come with a visual safety flag which should always be used. **CAUTION:** The use of the flag does not guarantee that others will see you; ride with caution and awareness of what is behind you. You may want to attach additional lights to the trailer, such as a blinking red taillight.

FIG. 5 Correct way to park bike and trailer. Note: correct direction to turn the handlebars is towards the trailer. Trailer and handlebars are 90 degrees to bike.

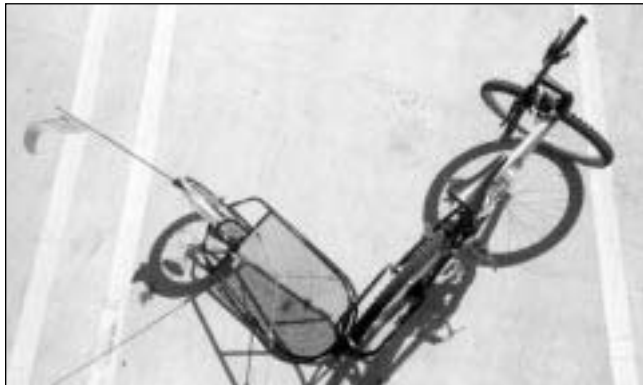

7

NIGHT RIDING

The COZ comes with a fender reflector. The YAK comes with wheel and fender reflectors. The reflectors must be correctly installed and properly maintained for night riding. Wheel reflector attachment is covered in the Reflector Installation section and fender reflector attachment is covered under Fender Assembly.

Make certain the reflectors on your bicycle are properly installed and in good working order. If you have any questions concerning this refer to your bike's Owner's Manual or consult your dealer.

When riding at night, never ride without lights or reflectors on both the bike and trailer. Contact your appropriate state government office to learn the legal lighting requirements for your state.

STEERING

The trailers will effect the steering of your bicycle. Take the following points into consideration and remember a bike with a trailer attached will behave differently:

Tire pressure - It is **CRITICAL** that the rear tire of your bicycle is inflated to the normal operating pressure embossed on the circumference of the tire. Under-inflated bike tires cause washout of the rear wheel and an unstable riding condition for the bike and trailer. Tire pressure on the trailers on the other hand, controls the amount of suspension your cargo will enjoy. Always maintain tire pressure for bicycle and trailer within the ranges suggested by the tire manufacturer.

Counterweight - Since the trailer is single wheeled and attached to the rear axle, it will follow the side to side movements of your bike. When standing to pedal, there is a natural tendency to rock from side to side. When the trailer is attached there will be added weight and the rocking effect will be more pronounced. Because of this, it will take more effort to stop the rocking of the trailer in one direction and reverse it to the other. Be extremely careful not to over-exaggerate this motion as extreme rocking will result in rapid weight transfer and the possible loss of control.

PARKING

There are two ways to best park your bike and trailer:

a) A very simple way to park your bike and trailer is to position it so it is parallel to a stable surface such as a building, fence, or sign post. With the bike approximately 10 - 12 inches from the structure gradually lean the bicycle over until it comes in contact with the structure. Check to make certain the bike and trailer are stable.

NOTE: Always park your bike and trailer on level ground.

b) With your bike turned 90 degrees to the trailer and your handlebars turned 90 degrees to the frame, the trailer will stand up on its own. Just lean the bike and trailer over while turning the bicycle handlebars perpendicular to the bicycle frame in the direction of the trailer and – viola!! See **Fig. 5**. This feature works best when the trailer is loaded.

To “un-park”, have one hand on the handlebars, and one hand on the seat. Walk forward with your bike, pulling

8

the seat towards you; the trailer will stabilize in the horizontal position.

CAUTION: A small percentage of bike's rear derailleurs are positioned such that when parked, the fork of the YAK contacts the derailleur pivot housing. **Fig. 3** Verify with a friend that there is adequate clearance before leaning the bike and trailer completely over in park mode. Note: reversing the installation of the QR (install from the drive side/right side of bike) helps eliminate this problem. B.O.B TRAILERS assumes no responsibility for bent derailleurs that result from the owner neglecting to check for proper clearance prior to utilizing “PARK MODE”. See **Fig 5a**.

FIG. 5a B.O.B QR installed from drive side/right side of bike.



9

YAK OFF ROAD RIDING SAFETY

Off Road Riding - The YAK is VERY off-road capable! The COZ is not designed for off road use. When pulling the YAK off-road it is important to observe the above points as all these precautions also apply to safe dirt riding. Off road riding, with its uneven terrain, loose surfaces, and unpredictability will tend to magnify these concerns. With a trailer attached, your off road maneuverability will be reduced and it is important to take this into consideration as you negotiate obstacles and choose which trails to ride.

SECURITY

We recommend using a "U LOCK" or standard cable lock system that is long enough to run through the rear triangle of your bike and the fork of the trailer **Fig. 1**.

**TAKE LONG
VACATIONS
WITH YOUR
FAMILY**

ASSEMBLY INSTRUCTIONS

NOTE: B.O.B TRAILERS IS NOT RESPONSIBLE FOR INJURY, DAMAGE, OR FAILURE THAT RESULTS FROM FAULTY ASSEMBLY OR MAINTENANCE AFTER SHIPPING.

The following instructions explain how to correctly assemble and attach your new trailer. If you do not have previous experience with trailer and bicycle assembly and maintenance, we recommend you have your trailer assembled and attached by a professional bicycle dealer.

FIG. 6 Flanges of "boom tube" and COZ flange bolts.

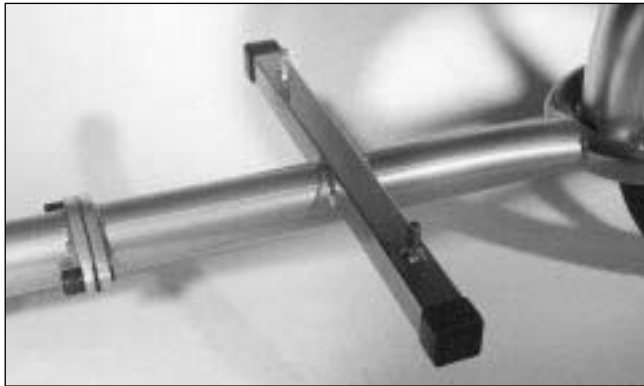

10

The following is a list of tools necessary to properly accomplish assembly, adjustment, and installation in accordance with the assembly instructions:

ALLEN WRENCHES
ADJUSTABLE WRENCH
STANDARD SCREWDRIVER
PHILLIPS-HEAD SCREWDRIVER
METAL CUTTING SAW
METRIC DIE; 5mm x .8mm

COZ FRAME ASSEMBLY

The COZ has a two piece frame which needs to be assembled prior to attaching the Action Packer™ box. Start by removing all items from the Action Packer™ and removing packing materials. Next remove the nuts and bolts from the flange on the "boom" tube as shown in **Fig. 6**. You will need a 6mm Allen wrench.

Align the two flanges and install the bolt, lock washer, and nut. When attaching the two halves make sure all the box attachment studs are pointing upward as shown in **Fig. 7**. Securely tighten the flange nuts and bolts.

Remove the knobs and large area washers from the cross braces. Place the Action Packer™ over the trailer frame and align the 4 holes in the Action Packer™ with the 4 bolts in the cross braces. With the holes and bolts aligned, set the box on the frame. Replace one of each of the large area washers over the bolts and install the knobs. Securely tighten the knobs.

11

FENDER ASSEMBLY

Fender Reflector Installation - The fender reflector attaches to the rear portion of the fender. The reflector has a threaded stud built into it. Attach the reflector to the fender by inserting the stud into the upper hole and the plastic "alignment pin" into the lower hole of the fender as shown in **Fig. 8**. Next, place the washer over the portion of the stud extending through the underside of the fender. Thread the nut on and tighten with an 8mm wrench.

Fender Bracket Attachment - First, attach the fender bracket to the fender. Place the fender bracket in the center of the two holes in the fender and align the mounting hardware with them as shown in **Fig. 9**. Insert the screws from the outside of the fender through the holes. Place the threaded backing plate on the inside of the fender and tighten the screws using a screw driver.

FIG. 8 The correct orientation of the rear reflector on the fender.

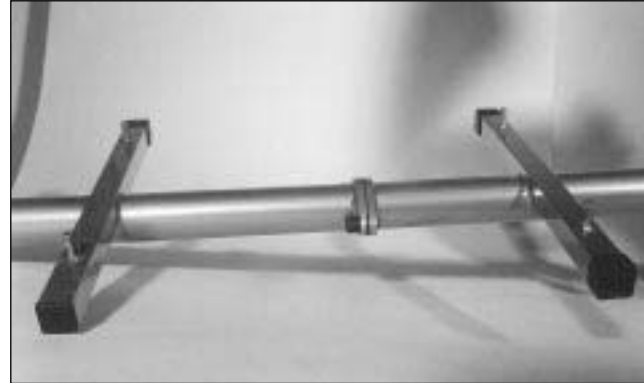
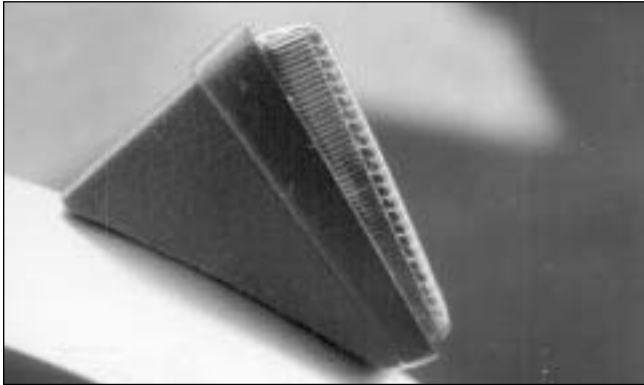

FIG. 7 COZ frame properly assembled with bolts pointing upward.

FIG. 9 Attach the fender bracket to the fender with mounting hardware as shown.

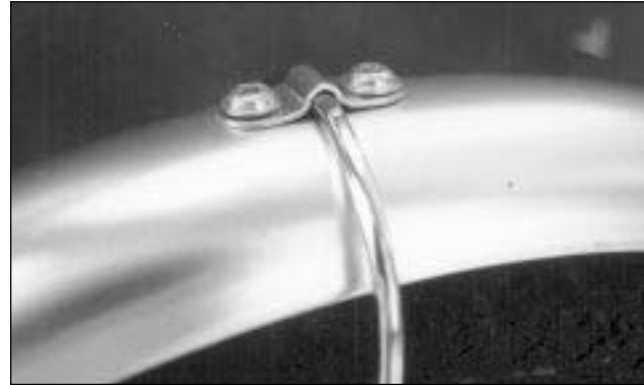



FIG. 10 Attachment of fender to trailer frame.

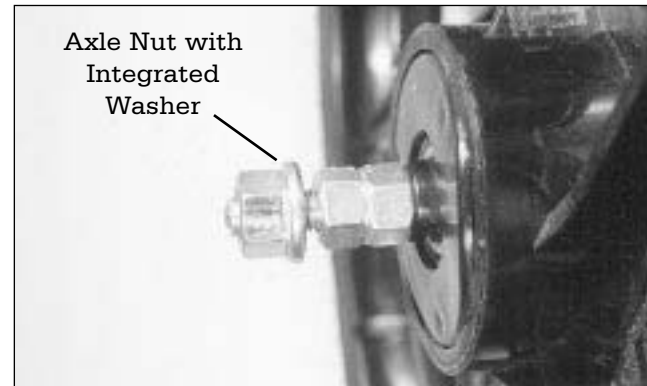

FIG. 11 Attachment of the fender to the dropout eyelet.

12 Fender Attachment - The fender attaches in three places. Begin by removing the screw and washers from the forward fender mount on the trailer frame. Attach the fender to the trailer by inserting the bolt and washer through the slot in the fender, then place the second washer behind it (sandwiching the fender with washers) as shown in **Fig. 10**. Tighten the bolt securely with a 4mm Allen wrench. Next, attach the fender brackets to the left and right dropouts. Insert the bolt through the washer and then through the loop in the fender bracket as shown in **Fig. 11**. Align the bolt with the eyelet in the dropout and tighten securely with a 4mm Allen wrench.

COZ Wheel Installation - **Fig. 12** shows the anatomy of a nutted axle wheel. Study this diagram carefully so you

FIG. 12 Anatomy of a nutted axle wheel.



become familiar with the names of the various parts. This will help you better understand the following instructions:

- 1) Remove the wheel from the box. Remove the plastic axle caps from the axle of the wheel. Loosen the axle nuts with a 14mm wrench.

- 2) The trailer's rear drop-out, **Fig. 13**, is slotted to receive the axle of the wheel. With the trailer facing forward, slide the wheel in the dropouts making sure the axle nuts are on the outside of the dropouts.

- 3) Make sure the wheel is centered between the wheel stays.

- 4) Using two 14mm wrenches, tighten the axle nuts. It is important that you tighten both nuts at the same time, tightening them against one another.

After tightening the axle nuts, make sure the wheel is still centered in between the wheel stays.

FIG. 13 Slotted rear dropout for axle insertion.

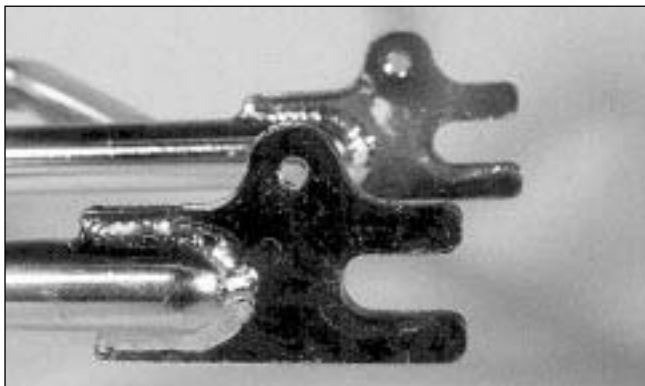

13

YAK Wheel Installation - Fig. 14 shows the anatomy of a wheel quick release. Study this diagram carefully so you become familiar with the names of the various parts. This will help you better understand the following instructions:

- 1) Remove the wheel and quick release from the small parts box. Remove the plastic axle caps from the axle of the wheel.

- 2) Install the quick release in the wheel by first unscrewing the adjusting nut, **Fig. 14**. To remove the adjusting nut, turn it in a counter clockwise direction. With the nut and one spring removed, insert the quick release through the hole in the axle. Re-install the spring with the small end towards the hub and thread the adjusting nut on by turning in a clockwise direction. At this point only tighten the

FIG. 14 Anatomy of a quick release.

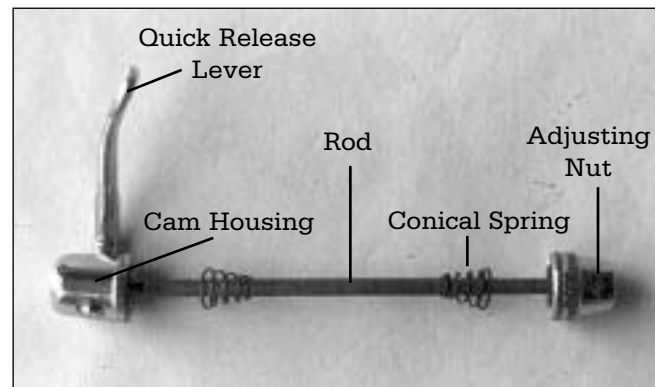

nut three turns. Final adjustment will be made after the wheel is installed in the trailer.

3) The trailer's rear drop-out, **Fig. 13**, is slotted to receive the axle of the wheel. With the trailer facing forward, slide the wheel in the dropouts so that the quick release lever is on the left hand side.

4) Make sure the wheel is centered between the wheel stays.

5) Be aware, the quick release is NOT a nut and bolt system. It is a cam-activated tightening mechanism. Securely tighten the quick release as follows:

a. Turn the quick release lever perpendicular (at a 90 degree angle) to the trailer, **Fig. 15**. Keep the quick release lever from turning while you tighten the adjusting nut by turning it in the clockwise direction until it comes in contact with the trailer dropout.

FIG. 15 Quick release perpendicular to the trailer

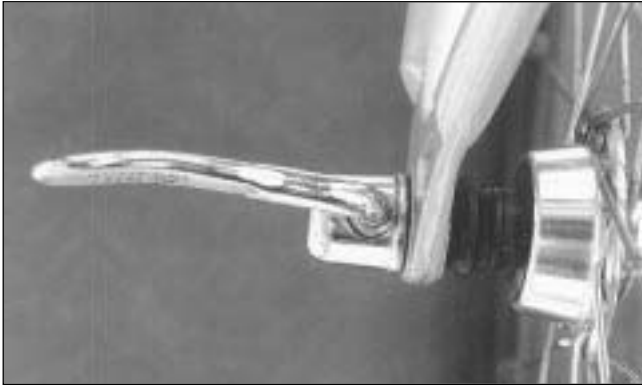

14

b. Turn the quick release lever towards the rear of the trailer to the closed position, **Fig. 16**. The word CLOSE should be clearly visible and the quick release lever should be parallel to the wheel stay. It should require considerable pressure to close the lever when it is properly adjusted and tightened. If you do not feel this resistance, turn the quick release lever back to the adjusting position, **Fig. 15**.

Tighten the adjusting nut by hand (it is not necessary to use tools) one or two more turns in the clockwise direction. Move the quick release lever toward the closed position, **Fig. 16**. When properly adjusted, it requires 80-105 inch/pounds of pressure to move the lever to the fully closed position.

NOTE: Follow all instructions exactly. If you are unsure how to operate the quick release, consult your bicycle dealer.

FIG. 16 Quick release in closed position.



Tire pressure - It is CRITICAL that the rear tire of your bicycle is inflated to the normal operating pressure embossed on the sidewall of the tire. Under-inflated tires cause wash-out of the rear wheel and an unstable riding condition for the bike and trailer. Tire pressure for the wheel on your trailer is embossed on the side wall of the tire. Tire pressure can be adjusted to offer differing degrees of suspension and rolling resistance.

NOTE: Inflation pressure must always fall within the range embossed on the sidewall of the tire.

COZ Reflector Installation - The COZ comes with wheel and rear fender reflectors. The wheel reflector is pre-installed. The installation of the rear fender reflector is covered under fender assembly.

YAK Reflector Installation - The YAK comes with two types of reflectors; a rear fender reflector and wheel reflectors. The

FIG. 17 Wheel reflector correctly positioned.



15 installation of the rear fender reflector is covered under fender assembly.

Every YAK comes with two spoke reflectors which mount onto the spokes of the trailer wheel. It is best to mount the reflectors 90 degrees from the valve stem **Fig. 17**. The reflectors should be installed by weaving them through the spokes. The reflectors attach to the spoke with the white slotted attachment "screw", **Fig. 18**. Remove attaching screw from reflector. Place reflector in position between wheel spokes and centered on a spoke approximately 90 degrees from valve stem. Install screw, **Fig. 18**, over spoke and into receiving hole of reflector. Using a screwdriver, turn screw 90 degrees clockwise to lock reflector in position. Repeat the above steps for the second reflector to be installed opposite the position of the first

FIG. 18 Wheel reflector.

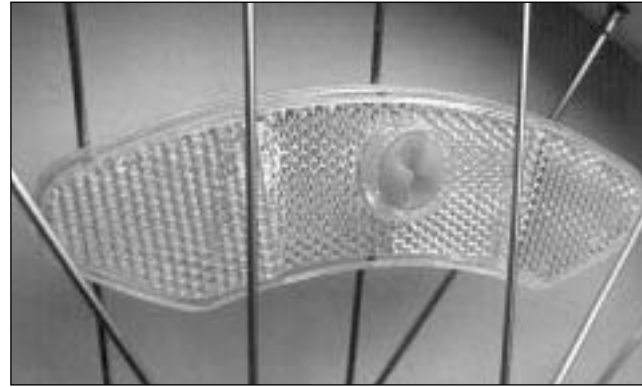

reflector. This reflector configuration will keep the trailer wheel balanced and vibration free.

Safety Flag - The trailers come with a two piece safety flag. The two pieces are attached to one another by means of a metal ferrule. Press the two metal ends of the flag sections together making sure they insert into one another completely. After attaching the two flag sections install into the flag mounting bracket located on the left wheel stay as shown in **Fig. 19** (COZ) Install into the flag mounting bracket located on the back of the cargo stop as shown in **Fig. 20** (YAK). The flag is extremely important in helping to make you visible to others. You should always make sure the flag is correctly installed when using your trailer. When removing the flag it is best to first remove it from the

FIG. 19 COZ Safety Flag Pole installed in mounting bracket.



16 trailer by pulling it out of the trailer mounting bracket by the lower half. To do this place your foot on the trailer to weight the trailer and remove the flag by pulling gently upward.

Front Fork Tightening

COZ - The front fork of the COZ pivots to the left and right. The fork pivots around the "boom" tube. The fork is fastened to the "boom" by a 5mm Allen bolt and lock washer, **Fig. 21**. As a final check before attaching your trailer, make sure the bolt is securely tightened. For reference, torque on bolts should be: 44 inch pounds

YAK - The front fork of the YAK pivots to the left and right between the upper and lower rail plates. The fork pivots around a pivot rod attached to the pivot plates. The pivot

FIG. 20 YAK Safety Flag Pole installed in mounting bracket.



17

rod is fastened to the upper and lower pivot plates by two 6mm Allen bolts and lock washers. **Fig. 22.** As a final check before attaching your trailer, make sure these bolts are securely tightened.

To tighten properly, insert a 5mm Allen wrench in each screw (top and bottom) and tighten against one another simultaneously.

B.O.B QUICK RELEASE INSTALLATION

Fig. 23 shows the anatomy of a B.O.B quick release. Study this diagram carefully and become familiar with the names of the various parts. This will assist you in understanding the following instructions. The B.O.B quick release must first be fitted to your bicycle before the trailer can be attached. The quick release installation procedure is as follows:

FIG. 22 Tighten YAK front fork pivot screws in the upper and lower pivot.



FIG. 21 Tighten COZ front fork pivot screw in the upper and lower pivot.

FIG. 23 Anatomy of a B.O.B Quick Release (QR).

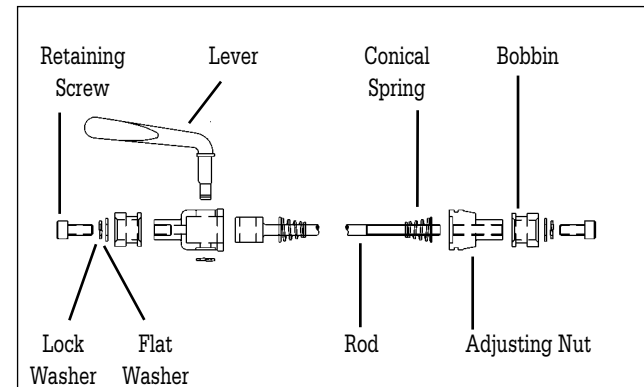

- 1) Remove your bike's rear wheel quick release by:
 - a. Moving the quick release lever from the closed to open position parallel to the bike frame as shown in **Fig. 24**. The word OPEN should be visible on the lever.
 - b. Next unscrew the adjusting nut, **Fig. 14**, by holding the lever in place and turning the adjusting nut in the counter-clockwise direction. Also remove the conical shaped spring.
 - c. Remove the skewer by pulling it through the hub in the direction of the lever.
- 2) For the B.O.B quick release to safely work with your bicycle, the overall dimension from outside to outside of your bike frame's rear wheel dropouts must fall within the following range:

Minimum: 140mm Maximum: 156 mm

FIG. 24 Bicycle quick release in open position.



18

- a. To determine the spacing of your frame, measure the dimension of your dropouts using a pair of calipers as shown in **Fig. 25**.

NOTE: If you do not understand the following instructions, your dealer can modify the length of the Quick Release rod as necessary to fit your bicycle properly. To determine the correct quick release rod length for your bike proceed as follows:

- b. The design of the B.O.B quick release allows for an 11 mm variation between minimum and maximum rod lengths. Many people have both road and mountain bikes. Mountain bikes typically have wider dropout spacing than road bikes. However, the variation between the bikes is usually less than 11 mm and allows the rod to be used in both bikes. If

FIG. 25 Measurement of outside to outside dimension of rear dropouts.

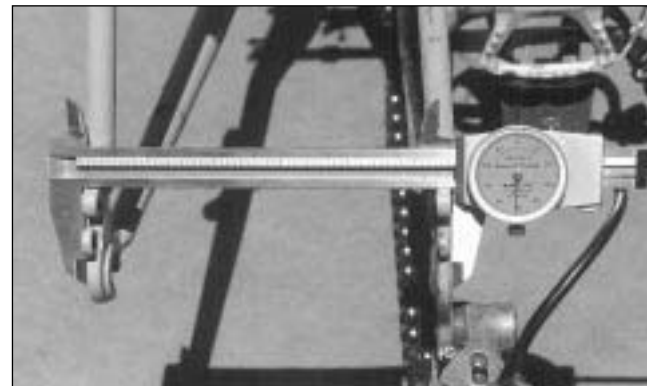

the variation is greater than 11 mm, you will need two quick releases.

c. With the quick release lever in the closed position, **Fig. 26**, insert quick release rod into axle. Measure the amount of thread extending past the drop out face, **Fig. 27**. (NOTE: **Fig. 27** shows an acceptable measurement) There must be a minimum of 10 mm and a maximum of 19 mm for the rod to be acceptable. If, for example, your measurement is 25 mm, subtract 19 mm (max. length) to determine length of rod to be cut. (25 - 19 = 6mm.) As a general rule, it is recommended to maximize the length of the rod.

Additional length can be cut to allow the QR assembly to fit different bike frames. Again: minimum dimension is 10mm. ref.: **Fig. 27**.

FIG. 26 Correct orientation of quick release in rear wheel.



19

d. Cut rod to correct length: With a ruler, measure from the tip of the QR rod and mark the dimension with a visible indelible marker; in this case, 6 mm. **Fig. 28**.

e. Before cutting the quick release rod it is important to thread a 5mm x .8mm die inward of the cut off mark. **Fig. 28**. This will allow the threads damaged during the cutting process to be repaired.

f. Clamp the quick release rod in a vise being careful not to damage the threads. Locate your cut off mark and cut the rod with a metal cutting saw. This is shown in **Fig. 28**.

g. With a file, shape the end of the rod to a conical shape like the end of the portion which was removed.

h. Back the die off by turning counter clockwise to clean up

FIG. 27 Measurement of the amount of the quick release rod extending beyond the face of the dropout. The quick release must be in the closed position (FIG. 26).



the threads. Verify the quick release rod has been cut to the proper length by repeating step c. above. If the quick release adjusting nut stops turning before it comes in contact with the frame, (note **Fig. 26**) the quick release rod is too long. Following steps c. through h. above, removing the excess length.

IF YOU HAVE ANY QUESTION CONCERNING THE CORRECT SIZING OR INSTALLATION OF THE B.O.B QUICK RELEASE, HAVE THESE OPERATIONS PERFORMED BY A PROFESSIONAL BICYCLE DEALER. IMPROPER SIZING, INSTALLATION, OR ADJUSTMENT OF THE B.O.B QUICK RELEASE CAN RESULT IN LOSS OF CONTROL, AND MAY RESULT IN BODILY INJURY OR DEATH.

FIG. 28 Quick release with die in place and clamped for cutting.

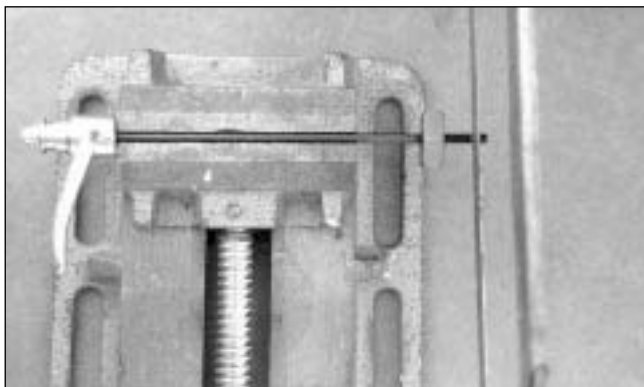

20

Quick Release Installation

Follow the steps outlined below for correct quick release installation:

- Insert one of the conical shaped springs over the quick release rod through the hole in the large end of the spring. From the non freewheel side of the bike insert the quick release through the hub as shown in **Fig. 26**.
- Install the other conical shaped spring on the quick release shaft through the hole in the small end of the spring. With the quick release lever perpendicular (at a 90 degree angle) to the frame, **Fig. 29**, tighten the adjusting nut. Hold quick release lever from turning while you tighten the adjusting nut by turning it in the clockwise direction until it is approximately 1.5mm the drop out, **Fig. 30**.
- Move the quick release lever towards the rear of the

FIG. 29 Quick release perpendicular to the frame.

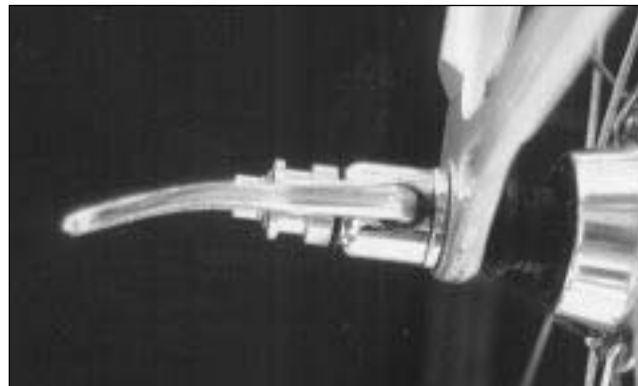

frame to the closed position, **Fig. 26**, to check the tightness and adjustment. The word CLOSE should be clearly visible and the quick release lever should be parallel to the frame. It should require considerable pressure to close the lever when it is properly adjusted and tightened. If you do not feel this resistance turn the quick release lever back to the adjusting position, **Fig. 29**. Tighten the adjusting nut by hand (it is not necessary to use tools) one or two more turns in the clockwise direction. Turn the quick release lever toward the closed position, **Fig. 26**. Proper adjustment requires 80 to 105 inch/pounds of pressure to move the lever to the closed position, **Fig. 26**.

FIG. 30 Adjusting approximately 1.5mm dropout.



21

Trailer Attachment

Now that the B.O.B quick release is correctly installed, attach the trailer to the quick release. To do this correctly, follow the steps below:

- a. The stainless steel pivoting BOBBINS on the quick release skewer are asymmetrical as shown in **Fig. 31**. This asymmetrical design allows the BOBBINS to be reversed, allowing for a variance of approximately 13mm in outside dimensional span of the bike's dropouts.
- b. With the bike stabilized and the trailer unloaded, check the fit between the fork hooks and the slots of the BOBBINS. It is easiest to do this with the bike in the upright position and trailer straight behind the bike. Stand on the

FIG. 31 Asymmetrical quick release bobbin.



22

left side of the bike facing towards the trailer. Allow the bike seat to rest against hip. Bend at the hips and lift trailer with both hands, **Fig. 32**, and place the YAK's fork hooks on the quick release BOBBINS. If the hooks do not fit into the BOBBIN slots by slightly expanding or compressing the fork, it will be necessary to reverse the BOBBINS. **Fig. 33** shows a situation where the hooks do not fit easily and the BOBBINS need to be reversed.

c. With the quick release installed, and using a 4mm Allen wrench, remove the BOBBIN retaining screws, **Fig. 23**, on both the left and right sides. Remove the BOBBINS and reverse them noting the position of the lock and flat washers.

d. With the BOBBINS reversed, reinstall the retaining screws and lock washers. Tighten the retaining screws securely.

e. Attach the trailer by aligning the slots of the BOBBINS with the slots in the fork hooks. **Fig. 34** shows the fork hooks correctly installed on the BOBBINS.

f. Insert the retaining pins into the fork hooks. **NOTE:** The pins can be clipped over the mesh in the bottom of trailer for easy access during installation. **Fig. 35** shows the small hole in the front edge of the dropout which the retaining pins insert into.

FIG. 32 Proper way to position yourself, bike, and trailer for attachment.



FIG. 33 Bobbin spacing does not align with hook spacing. Bobbins must be reversed for proper alignment.



On the non-derailleur side, insert the straight length of the pin into the hook hole. As the pin is inserted into the hook the loops of the pin will need to expand as they pass over the front edge of the hook. It is important the pin is inserted all the way so that the top edge of the second loop rests in the slot of the hook. A correctly installed pin for the non-derailleur side is shown in **Fig. 36**.

IMPORTANT: The pin on the derailleur side is installed as above and must be rotated perpendicular to the face of the trailer hook for proper clearance as shown in **Fig. 37**. Failure to do so will result in damage to the pin, derailleur, and quick release and adversely effect the attachment of the trailer, potentially resulting in the loss of control.

FIG. 35 Pin insertion hole in front edge of hook.

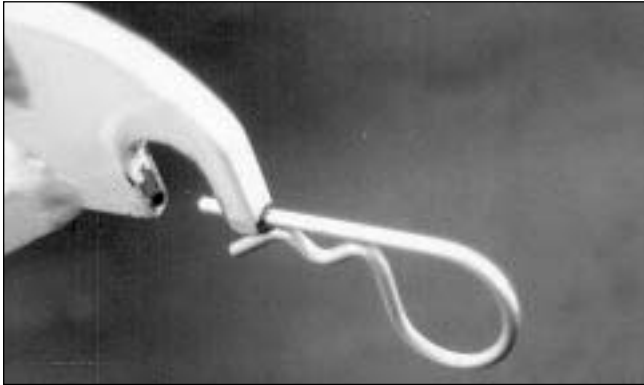

FIG. 34 Fork hooks correctly aligned and installed on bobbins.

FIG. 36 Retention pin correctly inserted into hook so top edge of second loop rests in hook slot.



IMPORTANT NOTICE: THE PINS ARE CRITICAL IN KEEP-
ING THE TRAILER ATTACHED TO THE QUICK RELEASE.
THE PINS SHOULD BE INSPECTED EVERY TIME YOU
RIDE. IF THE GAP BETWEEN THE LOOPS AND THE
SHAFT OF THE PINS EXCEEDS 1.5mm, [SEE FIG. 38], IT
SHOULD NO LONGER BE USED AND SHOULD BE DIS-
CARDED. NEW PINS ARE AVAILABLE THROUGH YOUR
DEALER.

FIG. 37 Derailleur side pin rotated perpendicular to outside face of trailer hook.



FIG. 38 Differences between a new pin and worn-out pin. The worn-out pin must not be used.

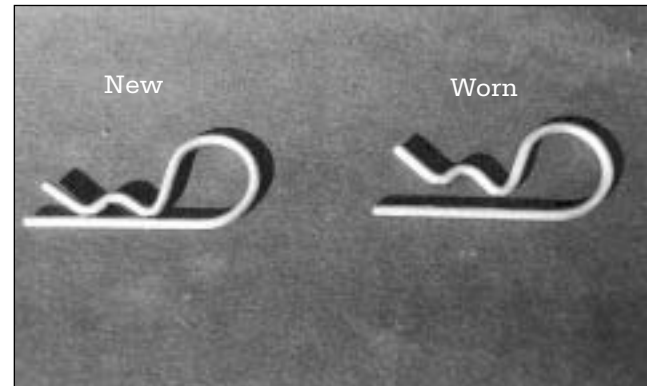

25

MAINTENANCE

Follow these steps to keep your new Trailer in proper operating condition. Study **Fig.1**, this illustrates the anatomy of both a COZ and YAK, to familiarize yourself with the name and location of parts. We recommend that after 30 days

you return your trailer to the shop from which you purchased it, for an initial check up. After this, follow the periodic maintenance and service table below.

MAINTENANCE SCHEDULE

Part	Service	Period**		Page	
		COZ	YAK	COZ	YAK
B.O.B QR	Check tightness	Every ride	Every ride	26	26
	Check for wear and damage	Monthly	Monthly	26	26
QR BOBBINS	Check retaining screw tightness	Every ride	Every ride	26	26
	Remove and clean bushing	Monthly	Monthly	26	26
	Replace	As needed	As needed	26	26
Hub Bearings	Check adjustment*	Monthly	Monthly	26	26
	Disassemble, clean, lubricate*	Six Months	Six Months	26	26
Retaining Pins	Inspect	Every ride	Every ride	27	27
Tire	Check Pressure	Weekly	Weekly	27	27
	Inspect for damage	Monthly	Monthly	27	27
Fork	Check pivot screw tightness	Weekly	Weekly	27	28
Fork Bushings	Check for looseness*	Yearly	Year	27	28
Wheel	True	N/A	As needed	28	28
Wheel Quick Release	Check tightness	N/A	Every ride	N/A	29
Axle Nuts	Check tightness	Every ride	N/A	29	N/A

* We recommend this service be performed by a trained bicycle mechanic at a professional bicycle dealership. This requires special tools and skill.

** May require more frequent service if you ride in wet, sandy, or dusty conditions. All the above frequencies are intended as guidelines. Depending on where you ride and your riding style, these services may need to be performed more frequently.

B.O.B Quick Release - Every time you ride, check that the B.O.B quick release is securely tightened in the frame. Reference items b. and c. of the B.O.B Quick Release Installation section for proper tightening procedures. At least once a month, and more often if you ride every day, or in the dirt, inspect the quick release to make certain it is in proper working order. Inspect parts for wear, tightness, and possible damage from passing objects. Refer to maintenance schedule for specifics.

B.O.B. QR BOBBINS - Each ride make certain your quick release BOBBIN retaining screws are securely tightened, **Fig. 23**. Once a month, or more often if you ride in wet or dirty conditions, remove the quick release BOBBINS, **Fig. 23**, and clean them. After removing the BOBBINS, wipe the posts on the cam housing and adjusting nut with a clean cloth to remove all dirt and foreign matter. Take this opportunity to inspect the axles for excess wear and straightness.

The BOBBINS can be cleaned by inserting a clean piece of cloth or swab into the hole and removing all foreign material and dirt. After cleaning the BOBBINS, lubricate the posts with a light grease, reinstall BOBBINS and tighten securely, taking note to install them in the same position from which they were removed.

Hub Adjustment - Every month check the hub adjustment on the trailer wheel as follows:

1. Elevate the trailer so the rear wheel is in the air.
2. Gently holding the wheel and keeping the trailer free

from movement, move the wheel from side to side. If there is movement, the axle cones are loose and require adjustment. This service should be performed by a trained bicycle mechanic at a professional bicycle dealership as it requires special tools.

COZ Hub Bearings - Once every six months, or more frequently if you ride daily or in wet conditions, the hub should be disassembled. The bearings, cones, and races, should be cleaned, inspected, and replaced if necessary. Lubricate the bearings and hub with a medium bearing grease and reassemble. As above, this service should be performed by a trained bicycle mechanic at a professional bicycle dealership as it requires special tools and skill. Pulling your trailer with an improperly maintained hub will cause damage to the bearings and bearing surfaces, requiring premature replacement.

YAK Hub Bearings - Once every six months, or more frequently if you ride daily or in wet conditions, the hub should be disassembled. The YAK uses hubs with cartridge bearings. The bearings, should be cleaned, inspected and replaced if necessary. Lubricate the bearings and hub with a medium bearing grease and reassemble. As above, this service should be performed by a trained bicycle mechanic at a professional bicycle dealership as it requires special tools and skill. Pulling your trailer with an improperly maintained hub will cause damage to the bearings and bearing surfaces, requiring premature replacement.

Retaining Pins - Inspect every time you ride to make sure they are in good condition and installed correctly. Trailer Attachment (pg. 21) explains how to correctly install and inspect the retaining pins. Worn-out or damaged pins should be replaced immediately.

Tire Pressure - Tires gradually lose air pressure. Check your tire air pressure weekly. With a tire pressure gauge verify that the pressure in your tire falls within the range embossed on the sidewall.

If you must add air to the tire we recommend using a hand pump with built in gauge. Compressed air should not be used. It inflates tires too quickly and can cause damage to the tube and tire.

Tire Inspection - Monthly, or more often if you ride daily or off road. Remove any foreign material such as glass, metal

fragments, and thorns from the tread. Inspect your tire tread and sidewalls for excessive wear, tears, rips, and gouges. If your tire shows excessive wear or damage, replace it to avoid blowouts or other failures.

If your tire is flat or needs replacement and you have not fixed or changed a tire previously, we recommend you have this job done by an experienced bicycle mechanic. It requires special knowledge and tools.

COZ Trailer Fork - The pivot screw for the front fork of your trailer should be checked weekly for tightness. The procedures are explained under COZ Front Fork Tightening in the Assembly section.

The front fork pivots on Delrin Bushings and is prelubricated during manufacture **Fig. 39**. If the fork squeaks during rotation use a minuscule amount of spray lubricant such as TRI FLO™. Otherwise, the bushings will give you years of service. See Maintenance Schedule for other service information. Inspect for tightness of the bearing to pivot rod assembly and replace approximately every two years or when excess looseness can be felt.

To remove the fork and bushings, proceed as follows: Remove pivot screw and "boom" tube cap with a 5mm Allen wrench. Remove the fork from the "boom" tube by rotating the fork from side to side and pulling the fork off. Use blunt punch and mallet to remove bushings. Drive them out with gentle taps from a mallet.

Reinstall bushings by using an arbor press or soft face mallet, tapping the bushing into the pivot tube until it contacts the flange. Apply a light grease to the bushings.

FIG. 39 COZ fork and Delrin bushing assembly

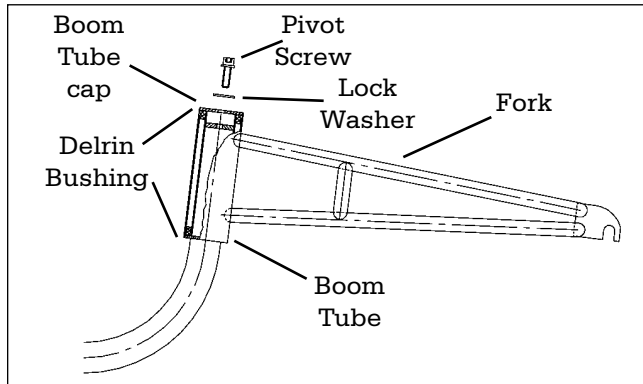

Reinstall fork by rotating it from side to side and pushing it down over the boom tube. When the fork is correctly installed, the “boom” tube will penetrate the upper fork bushing.

Tighten the fork by replacing the “boom” tube cap, lock washer and tightening the pivot screw with a 5mm Allen wrench. The pivot screw should be tightened to 43 ft/lbs of torque.

YAK Trailer Fork - The pivot screws for the front fork of your trailer should be checked weekly for tightness. The procedures are explained under YAK Front Fork Tightening in the Assembly section.

The front fork pivots on Delrin Bushings and is prelubricated during manufacture **Fig. 40**. If the fork squeaks during rotation use a minuscule amount of spray lubricant such as TRI - FLO™. With minimal maintenance, the bushings will give you years of service. See Maintenance Schedule for other service information. Inspect for tightness of the bearing to pivot rod assembly and replace approximately every two years or when obvious looseness can be felt.

To remove rod and bushings, proceed as follows: Remove pivot rod by removing existing pivot screw and installing a 35mm long 5mm x .8 screw into the end. Tap the screw head until 25mm are exposed on the opposite end. Install screw on opposite end of pivot rod and pull gently with pliers to remove pivot rod. Use a blind hole puller and slide hammer to remove bushings, or insert a 6.5mm diameter x 280 mm punch through one bushing hole and drive it out with gentle taps from a mallet. Reinstall

bushings by using an arbor press or soft face mallet, tapping the bushing into the pivot tube until it contacts the flange. Install pivot rod by soft face mallet after applying a thin coat of medium grease to each end.

COZ Wheel - Monthly, or more often if you ride daily or on rough roads, inspect your trailer’s wheel. Lift the trailer and spin the wheel slowly. Check to make certain the wheel does not wobble side to side.

If the wheel wobbles from side to side, your wheel may need to be trued (straightened) or replaced. The COZ has a nylon wheel and there is limited ability to straighten these once they are misaligned. This is a job for a trained bicycle mechanic. It requires special tools and knowledge.

FIG. 40 YAK fork and Delrin bushing assembly

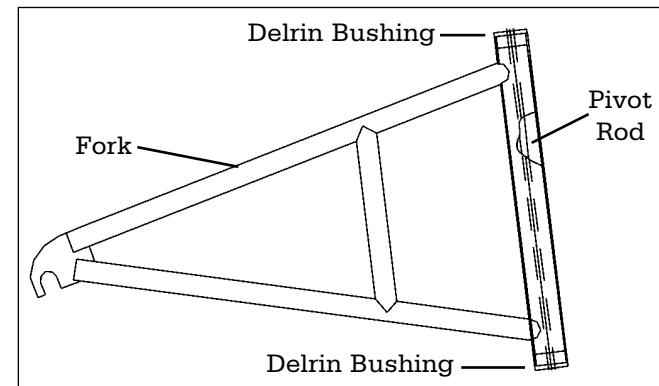

YAK Wheel - Monthly, or more often if you ride daily or off road, inspect your trailer's wheel. Lift the trailer and spin the wheel slowly. Check to make certain the wheel does not wobble side to side. Stop the wheel and check to make sure all the spokes are tight. The spokes in the wheel have left and right sides and you will see spokes on the same side crossing one another. Above the point where the spokes cross, grab the two spokes and try to squeeze them together. The spoke should be tight and resist squeezing. If the wheel wobbles from side to side or the spokes are loose the wheel will need to be trued (straightened). This is a job for a trained bicycle mechanic. It requires special tools and knowledge.

COZ Axle Nuts - It is important that your wheel's axle nuts remain tight. Please refer to the COZ Wheel Installation section for proper quick release adjustment and tightening instructions.

YAK Wheel Quick Release - It is important that your wheel's quick release remains tight. Please refer to the YAK Wheel Installation section for proper quick release adjustment and tightening instructions.

B.O.B. Trailers, Inc. warrants original parts of B.O.B trailers products to be free from defects in materials and workmanship subject to the following conditions and limitations:

- Frame is warranted for life of the product.
- Components are warranted for one year.
- Warranty is only valid for the original purchaser.
- Proof of purchase is required to exercise this warranty.
- Labor and transportation are not included.
- Normal wear, neglect, abuse, accidents, improper assembly or maintenance, or the installation of parts or accessories not compatible with the original intended use of the trailer, as sold, are not covered by this warranty.
- Warranty claims must be made through an authorized dealer.
- This warranty is limited to the replacement of the defective part at no cost. B.O.B Trailers shall in no event be responsible for consequential or special damages.
- This Limited Warranty is the only express or implied warranty applicable to B.O.B. Trailers. Any implied warranties, including warranties of merchantability and fitness shall be limited in scope and duration in accordance with this limited warranty.

BOOMER Kid Trailers

Improving upon the attachment and performance of traditional two wheeled child trailers, B.O.B has developed the BOOMER and BOOMER D'LUX. For these trailers, a new centerline attachment system has been created using the patented B.O.B Quick Release Trailer Attachment System. The BOOMERS hook up to a bicycle just like the COZ and YAK while providing safety and stability for you and your child. No more single arm that clamps to the chain stays! Its the only system that works on full suspension bikes! See your local B.O.B dealer for more information, or call B.O.B Trailers! (805) 541-2554

BOOMER SPECIFICATIONS:

- FRAME:Hi tensile steel
- WEIGHT:27lbs/12.3kg
- CAPACITY:100lbs/45.5kg
- WHEELS:Steel hub and rim/plated spokes/
sealed cartridge bearings

BOOMER D'LUX SPECIFICATIONS:

- FRAME:Aluminum alloy (6061 T6)
- WEIGHT:22lbs/10kg
- CAPACITY:100lbs/45.5kg
- WHEELS:Alloy hub and rim/stainless steel
spokes/sealed cartridge bearings

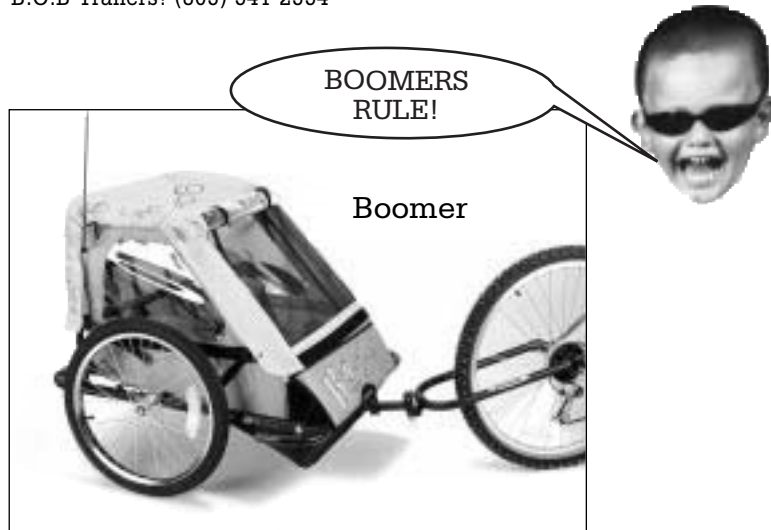

B•O•B Accessories

The B.O.B Quick Release attachment system enables you to use the trailer with virtually any bike: road, cruiser, tandem, recumbent, and mountain (including full suspension.) If you have more than 1 bike you will be using your trailer with, an extra quick release is essential.

Its simple! Just swap the quick release from the rear wheel of your bike for the B.O.B QR. It takes seconds!

Here at B.O.B we leave B.O.B QRs in all our bikes so they are ready for action any time: cruisers, full suspension Mtn bikes, barn burners, recmbents and city scorchers.

QR Model	Dropout Spacing
B.O.B QR	126.5mm to 140mm
B.O.B 145 QR	145mm
B.O.B Santana QR	160mm

B.O.B Quick Release

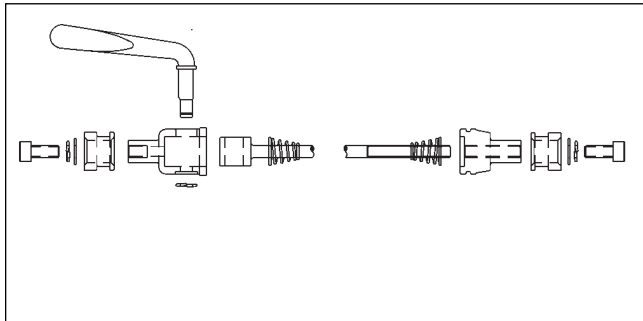

31

B•O•B NUTZ™

The B.O.B Nutz attachment system enables you to use the trailer with bikes having solid rear axles and internal geared hubs (IGH). Its simple! Just swap the existing axle nuts for the B.O.B Nutz. B.O.B Nutz are available in a variety of different axle diameters and thread pitches (see **Fig. 2** and below).

Model	Axle Dia.	Thread Pitch	Common Applications
3/8 x 24	3/8 inch	24 tpi	Single speed coaster brake hubs
3/8 x 26	3/8 inch	26 tpi	Shimano Nexus 4 and 7 speeds, Shimano 3 speed coaster brakes, English and Japanese solid axles
10 x 1	10mm	1mm	ISO and Japanese solid axles
IGH	10.5mm	1mm	Sachs multi-speed hubs with indicator chain shifting
	13/32 inch	26 tpi	Sturmey Archer multi-speed hubs with indicator chain shifting

B.O.B Nutz for internal Gear Hubs (I.G.H.)



SPECIFICATIONS:

32

	COZ	YAK
FRAME	Thin wall High Tensile Steel tubing	Tig welded construction 4130 CrMo 16mm round tubing.
FINISH	Powder Coated	Powder Coated
CARGO AREA	Rubbermaid 15 1/2 Gallon, 3600cu. inch ActionPacker™	1.14m x 432mm x 356mm (45"L x 17"W x 11"H) (25" x 16" x 18" cargo platform area)
WEIGHT	8.6 kilos (19 pounds)	5.59 kilos (12.3 pounds)
LOAD CAPACITY	22.7 kilos (50 pounds)	32 kilos (70 pounds)
WHEEL	16 x 1.75 Nylon wheel, steel hub, solid axle	16 x 1.75 alloy rim, quick release, cartridge ,bearing hub stainless steel spokes
ATTACHMENT	B.O.B Patented Quick Release Centerline Attachment System	B.O.B Patented Quick Release Centerline Attachment System
ACCESSORIES	B.O.B QR, Two-piece safety flag, fender, reflectors, duckness	B.O.B QR, Two-piece safety flag, fender, reflectors, duckness
FEATURES	The Rubbermaid® Action Packer box (forest green shell with black lid) provides a lockable, waterproof cargo space. Trailer frame disassembles and fits inside box for storage and shipping. Generally, trailer has a high level of duckness. Universally mounts to Mountain Bikes, Road Bikes, Tandems, and Recumbents. Quickly adapts to virtually every bike with a rear quick release or solid axle rear hub	Fork rotates 180 degrees for easy compact storage: 940mm x 430mm x 280mm (37"L x 17"W x 11"H) stored dimension. NOTE: Fork on XL models does not rotate 180 degrees. Universally mounts to mountain Bikes, Road Bikes, Tandems, and Recumbents. Quickly adapts to virtually every bike with a rear quick release or solid axle rear hub. Optional (but very desirable if you don't have one): The YAK Sak: a modular, 94 liter (5700 cubic in.) weather resistant, coated Cordura nylon duffel sack.

NOTES:

* Our products are designed and tested in the US and manufactured in Taiwan under US supervision.

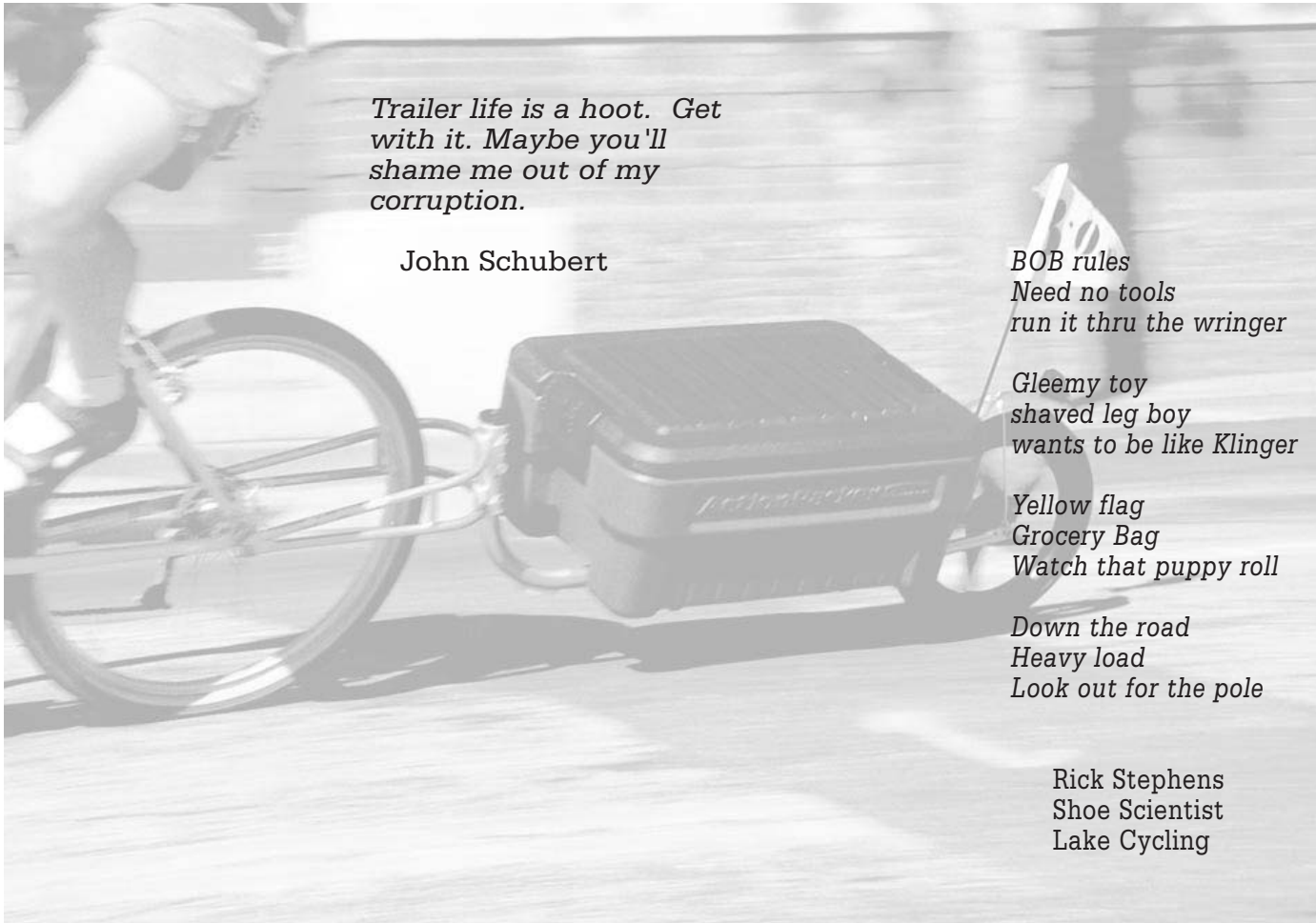

*Trailer life is a hoot. Get
with it. Maybe you'll
shame me out of my
corruption.*

John Schubert

*BOB rules
Need no tools
run it thru the wringer*

*Gleemy toy
shaved leg boy
wants to be like Klinger*

*Yellow flag
Grocery Bag
Watch that puppy roll*

*Down the road
Heavy load
Look out for the pole*

Rick Stephens
Shoe Scientist
Lake Cycling

B·O·BTM

3641 Sacramento Dr. #3
San Luis Obispo
California 93401



**QUESTION
INTERNAL
COMBUSTION**

B.O.B. Trailers 805-541-2554 FAX: 805-543-8464 <http://www.callamer.com/bobinc>
E-mail: bobinc@callamerica.com – produced by B.O.B. Graphics Division, floor 69