

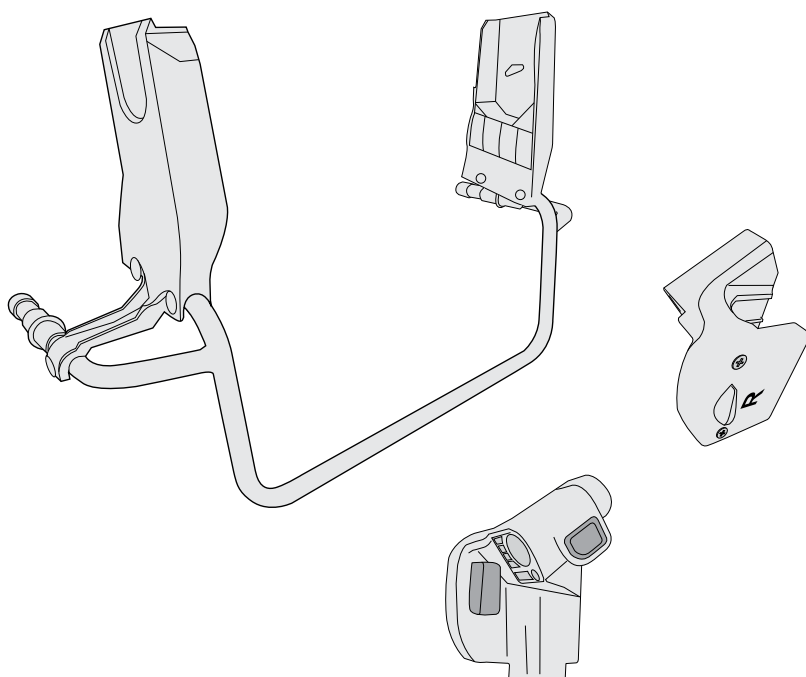

B·O·B[®]
GEAR

BOB Gear[®] by Britax (888) 427-4829 or (704) 409-1699
4140 Pleasant Road, Fort Mill, South Carolina 29708
www.bobgear.com



NUNA[®] | CYBEX[®] | BRITAX[®] | BOB GEAR[®]
INFANT CAR SEAT ADAPTER (ICSA)

ADAPTATEUR DE SIÈGE D'AUTO

ADAPTADOR PARA ASIENTO DE SEGURIDAD

IMPORTANT

THIS USER GUIDE CONTAINS A MANDATORY ARBITRATION CLAUSE AND CLASS ACTION WAIVER (“ARBITRATION AGREEMENT”) THAT AFFECTS YOUR LEGAL RIGHTS, REQUIRES YOU TO ARBITRATE DISPUTES, AND LIMITS THE MANNER IN WHICH YOU CAN SEEK RELIEF.

IMPORTANT

LE PRÉSENT GUIDE D’UTILISATION CONTIENT UNE CLAUSE D’ARBITRAGE OBLIGATOIRE ET UNE RENONCIATION AU RECOURS COLLECTIF (« CONVENTION D’ARBITRAGE ») QUI A UNE INCIDENCE SUR VOS DROITS LÉGAUX, VOUS OBLIGE À ARBITRER LES LITIGES ET LIMITE LA FAÇON DONT VOUS POUVEZ DEMANDER UN REDRESSEMENT.

IMPORTANTE

ESTA GUÍA DEL USUARIO CONTIENE UNA CLÁUSULA DE ARBITRAJE OBLIGATORIO Y RENUNCIA A DEMANDA COLECTIVA (“ACUERDO DE ARBITRAJE”) QUE AFECTA SUS DERECHOS LEGALES, REQUIERE QUE ARBITRE LAS DISPUTAS Y LIMITA LA MANERA EN QUE PUEDE SOLICITAR COMPENSACIÓN.

BOB®, BOB Gear®, BRITAX®, and Wayfinder™ are trademarks owned by Britax. NUNA® is a trademark owned by Nuna Intl BV. CYBEX® is a trademark owned by Goodbaby International. ©2023 All Rights Reserved. This product and its components are subject to change without notice.

BOB®, BOB Gear®, BRITAX®, et Wayfinder™ sont des marques de commerce qui appartiennent à Britax Child Safety, Inc. NUNA® sont des marques de commerce qui appartiennent à Nuna Intl BV. CYBEX® sont des marques de commerce qui appartiennent à Goodbaby International. Tous droits réservés, © 2023. Ce produit et ses composants peuvent faire l’objet de modifications sans préavis.

BOB®, BOB Gear®, BRITAX®, y Wayfinder™ son marcas registradas propiedad de Britax Child Safety, Inc. NUNA® ison marcas registradas propiedad de Nuna Intl BV. CYBEX® son marcas registradas propiedad de Goodbaby International. Todos los derechos reservados 2023. Este producto y sus componentes están sujetos a cambios sin previo aviso.



WELCOME TO BOB GEAR

For updates to this user guide, warranty and other recent product notifications, please visit [bobgear.com](https://www.bobgear.com) periodically or any time before making approved changes or adding approved equipment to your stroller.

Table of Contents

Safety Information	2
WARNINGS.....	2
NOTES.....	2
Features	3
INFANT CAR SEAT ADAPTER (ICSA) FOR NUNA®/ CYBEX®/ MAXI-COSI® INFANT CAR SEATS	3
STROLLER RECEIVERS	3
Compatibility	4
BRITAX® & BOB GEAR® INFANT CAR SEATS.....	4
Installing Your ICSA System	6
IDENTIFYING RECEIVER TYPE.....	6
ATTACHING REMOVABLE RECEIVERS TO STROLLER WITHOUT BUILT-IN RECEIVERS	7
ATTACHING ICSA TO STROLLER.....	9
Infant Car Seat Installation	10
PREPARING TO ATTACH INFANT CAR SEAT	10
ATTACHING INFANT CAR SEAT	11
REMOVING INFANT CAR SEAT FROM THE STROLLER	12
Removing Your ICSA System	12
REMOVING ICSA FROM STROLLER RECEIVERS.....	12
DETACHING REMOVABLE RECEIVERS FROM STROLLER	13
Care and Maintenance	13
CLEANING.....	13
Stroller Accessories	13
Warranty	14
Arbitration Agreement	15

Safety Information

WARNING!

Failure to follow all warnings and instructions could result in **SERIOUS INJURY OR DEATH.**

Read these instructions carefully before using this product. To ensure proper use, store this user guide in a convenient place so it can be consulted often.

- Never leave children unattended in the stroller or infant car seat.
- Always follow the infant car seat manufacturer's instructions. Do not exceed the manufacturer's instructions for maximum load carrying capacity of the infant car seat. Exceeding carrying capacity may cause the stroller to become unstable and tip resulting in serious injury.
- Do not use off-road or on uneven terrain when using the infant car seat adapter with an infant car seat installed. Doing so may cause the stroller to become unstable and tip resulting in serious injury.
- Do not run or jog when using infant car seat adapter with infant car seat.
- Avoid finger entrapment or injury. Always ensure any child occupants or bystanders are away from the stroller while folding or unfolding.
- Avoid serious injury from falling or sliding out. Always use infant car seat harness.
- Do not modify the infant car seat adapter or remove any labels. Doing so voids the warranty and could lead to a dangerous condition.

NOTES

- Always keep your infant car seat carry handle locked in the vertical/carry position while in stroller, as extra protection for your child.
- Always confirm infant car seat adapter is properly locked in place in stroller accessory adapters prior to use.
- Always confirm infant car seat is secured to infant car seat adapter.
- Do not place children directly in the stroller seat with the infant car seat adapter installed. Remove infant car seat adapter from stroller prior to placing a child directly into the stroller seat.
- Care must be taken when attaching infant car seat to infant car seat adapter to make sure hands and fingers are clear of contacting surfaces.
- Always remove infant car seat adapter before folding stroller to prevent damage.
- Always remove infant car seat adapters when not in use.

Features

INFANT CAR SEAT ADAPTER (ICSA) FOR NUNA® / CYBEX® / MAXI-COSI® INFANT CAR SEATS

ICSA:

Receivers

Removable Receivers:

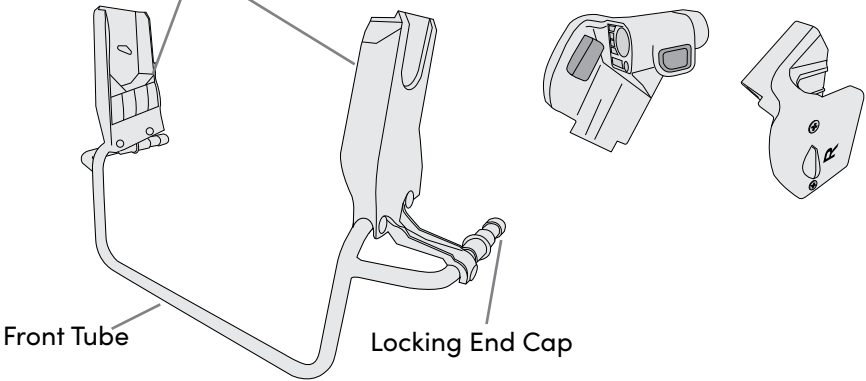

STROLLER RECEIVERS

REMOVABLE RECEIVERS

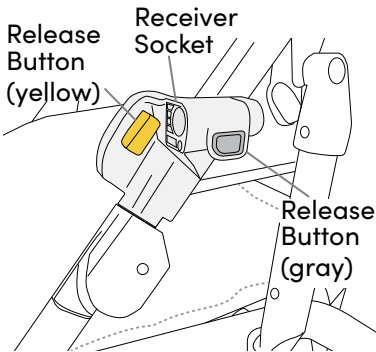

- **Receiver Socket:**
Securely connects the locking end cap of the ICSA to the removable receiver.
- **Release Button (Yellow):**
While pressed, allows the removable receiver to be detached from the stroller.
- **Release Button (Gray):**
While pressed, allows the locking end cap of the ICSA system to be detached from the receiver socket.

BUILT-IN RECEIVERS

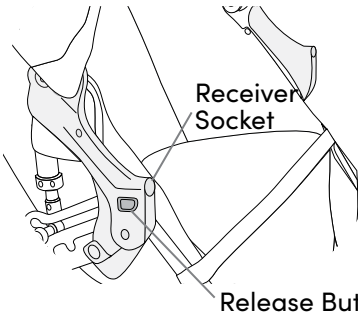

- **Receiver Socket:**
Securely connects the locking end cap of the ICSA to the built-in receiver.
- **Release Button (Gray):**
While pressed, allows the locking end cap of the ICSA system to be detached from the receiver socket.

Compatibility

This infant car seat adapter (ICSA) system is designed for use with the BOB Gear® Alterrain™, Alterrain Pro™, and Flex™ strollers, select Britax® infant car seats, select BOB Gear® infant car seats, and select NUNA®/CYBEX®/MAXI-COSI® infant car seats. See bobgear.com/carseatadapters for specific stroller model and car seat compatibility information. Do not use with infant car seats other than those specifically mentioned.

BRITAX® & BOB GEAR® INFANT CAR SEATS

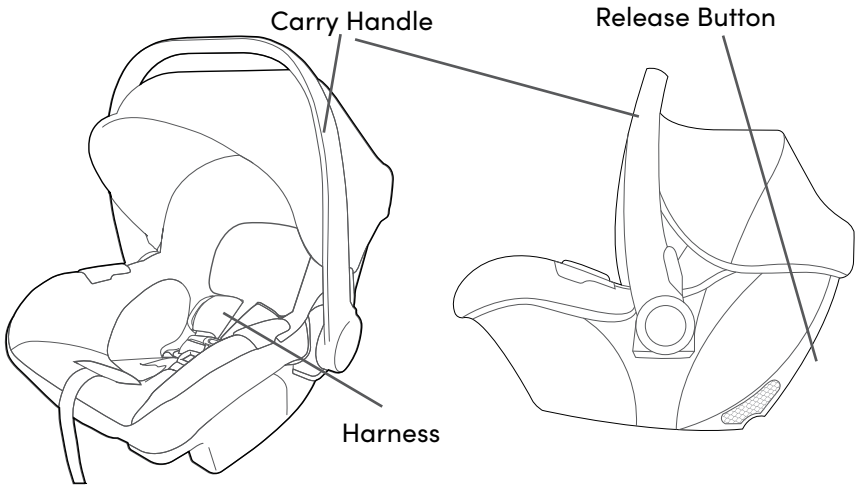

NOTE: Britax® Willow™ shown. See infant car seat user guide for more information on car seat features and installation.

NOTE: Not compatible with Britax® B-Safe™ infant car seats.

Actual product may vary from images

Installing Your ICSA System

IDENTIFYING RECEIVER TYPE

⚠️ WARNING!

Failure to attach ICSA securely to stroller may result in serious injury or death.

NOTE: This package includes two removable receivers. These receivers are to only be used on strollers WITHOUT “built-in receivers” (See below reference illustration). Once installed on the stroller, these receivers allow a stroller without built-in receivers to accept an infant car seat adapter (ICSA).

For strollers WITH built-in receivers, please skip to page 9 for instructions on how to attach the ICSA.

**Stroller WITH
Built-in Receivers**

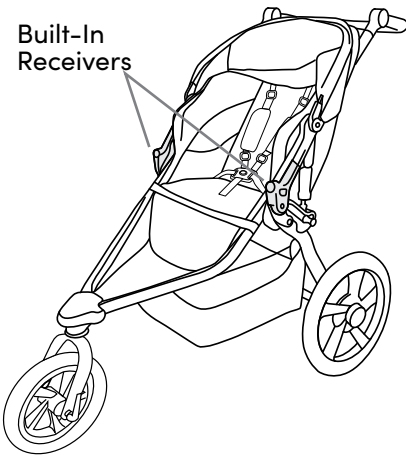

**Stroller WITHOUT
Built-in Receivers**

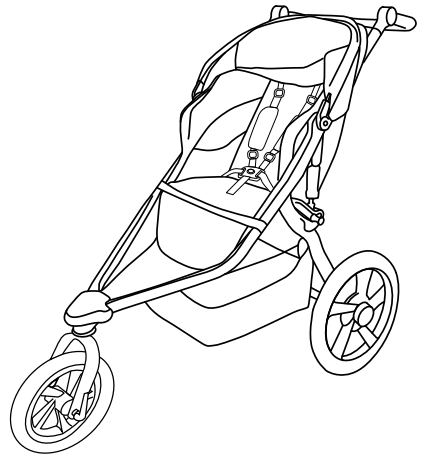

ATTACHING REMOVABLE RECEIVERS TO STROLLER WITHOUT BUILT-IN RECEIVERS

NOTE: When the stroller has built-in receivers, do not use the removable receivers included with the ICSA system. Please set them aside.

1. Prepare Stroller

- (A) Set parking brake.
- (B) Rotate canopy towards handlebar.

NOTE: For more information see stroller user guide.

2. Identify the “R” for right and “L” for left embossed on the inside of the receivers.

Receivers will need to be installed on the child’s respective side (e.g. the “R” receiver on the child’s right when sitting in the seat). For an additional check, identify the “BOB Gear® Logo” embossed on the receivers. The logo will always be facing the outside of the stroller when installed correctly.

Right Inside Facing

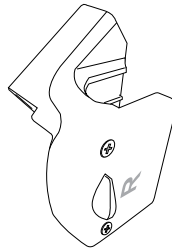

Left Outside Facing

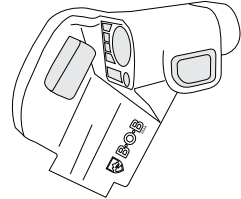

3. Locate yellow locking pins.

Identify the fabric opening within the seating area alongside the frame. Pull fabric away from the frame to reveal two yellow locking pins.

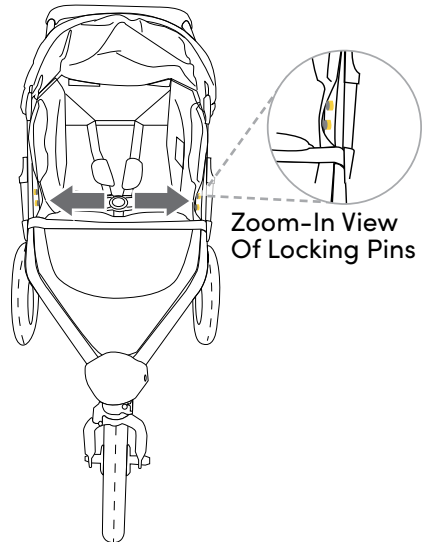

4. Attach Receivers

Slide receiver into the fabric opening, aligning with the yellow locking pins. Push down on the receiver to engage with the locking pins and securely attach to the stroller. Repeat steps on opposite side to install the second receiver.

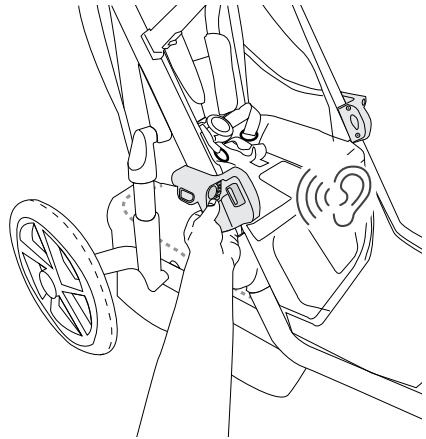

NOTE: The removable receivers are securely attached when you hear a “click” and see a green bar revealed within the yellow button of the receiver. If the green bar is not visible and you do not hear a click, slide receiver up and down or reinstall to ensure a secure attachment.

Green Bar

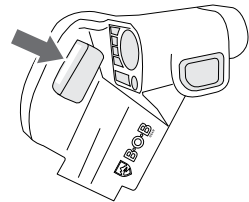

5. Verify Attachment

Ensure green bars are visible and pull on each receiver to verify secure attachment. Your stroller is now converted so that it can receive an infant car seat adapter (ICSA).

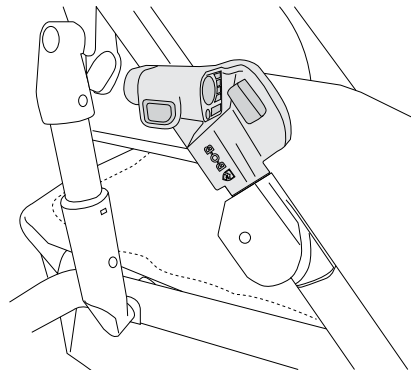

ATTACHING ICOSA TO STROLLER

NOTE: When the stroller has built-in receivers, do not use the removable receivers included with the ICOSA system. Please set them aside.

1. Prepare Stroller

- (A) Set parking brake.
- (B) Rotate canopy towards handlebar.

NOTE: For more information see stroller user guide.

2. Attach Adapters

Push ICOSA locking end caps straight into receiver sockets fully.

NOTE: Listen for click or snap noise on each side.

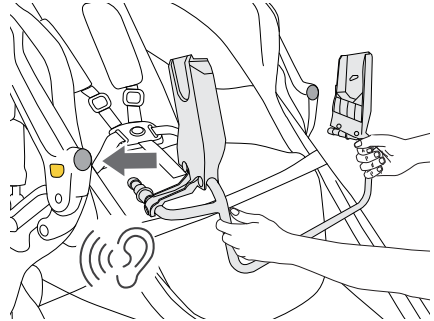

3. Verify proper installation.

Pull on each end (left and right) of ICOSA front tube to verify ICOSA is securely locked into place.

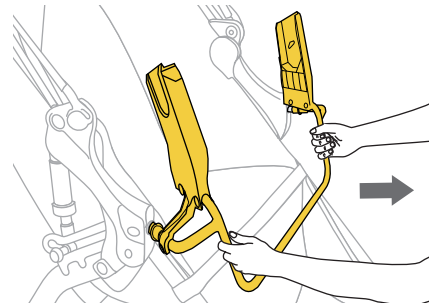

Infant Car Seat Installation

PREPARING TO ATTACH INFANT CAR SEAT

⚠ WARNING!

Failure to attach ICSA securely to stroller may result in serious injury or death.

- 1. Practice Attaching Car Seat**
Practice attaching and removing unoccupied infant car seat several times until the function becomes familiar before attaching infant car seat to ICSA for the first time.

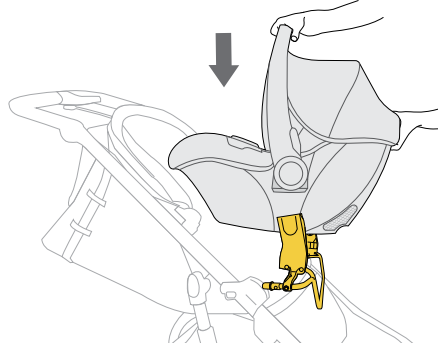

- 2. Secure Child**
Place infant into infant car seat. Fasten harness securely.

NOTE: For more information see infant car seat user guide.



- 3. Position Carry Handle**
Move infant car seat carry handle into upright, carrying position.

NOTE: Infant should always be secure in the infant car seat harness when using the stroller.

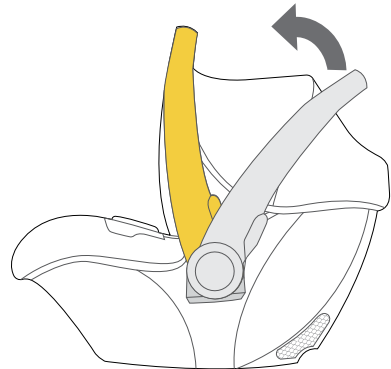

ATTACHING INFANT CAR SEAT

⚠️ WARNING!

Failure to attach infant car seat to ICSEA may result in serious injury or death.

1. Prepare Stroller

- (A) Set parking brake.
- (B) Recline stroller seat.
- (C) Rotate canopy towards handlebar.

NOTE: For more information see stroller user guide.

2. Align infant car seat.

Place infant car seat rear facing, directly centered on top of ICSEA, and align side hooks on infant car seat with receivers on ICSEA.

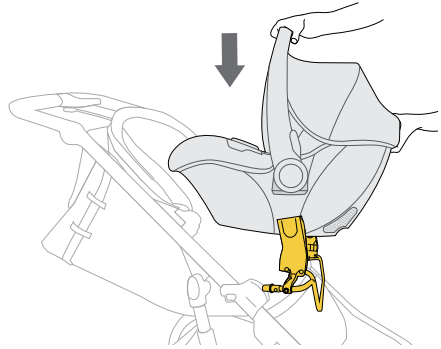

3. Attach infant car seat.

Push infant car seat straight down onto ICSEA until secure.

NOTE: Listen for click or snap noise on each side.

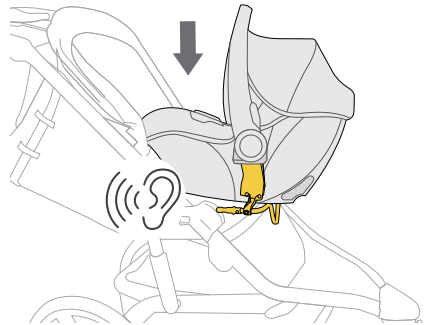

4. Verify Attachment

Pull up on both sides of the infant car seat to verify attachment

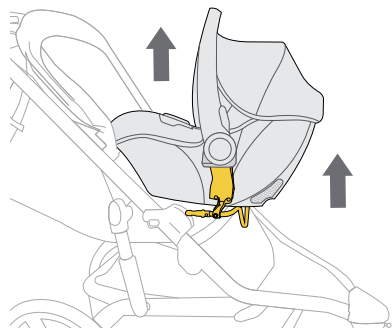

REMOVING INFANT CAR SEAT FROM THE STROLLER

1. Prepare Stroller

- (A) Set parking brake.
- (B) Rotate canopy towards handlebar.

NOTE: For more information see stroller user guide.

NOTE: If infant car seat handle is down, move handle into upright, carrying position.

2. Remove infant car seat.

- Lift the infant car seat away from the ICSA, while pressing the release buttons.

NOTE: For more information see infant car seat user guide.

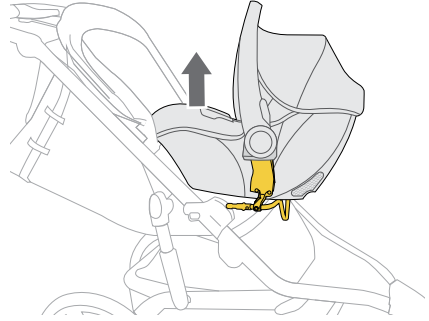

Removing Your ICSA System

REMOVING ICSA FROM STROLLER RECEIVERS

1. Prepare Stroller

- (A) Set parking brake.
- (B) Rotate canopy towards handlebar.

NOTE: For more information see stroller user guide.

2. Remove ICSA from receivers.

- Press the gray receiver release buttons while pulling ICSA forward and out of receiver sockets, keeping alignment even, left to right, as you pull.

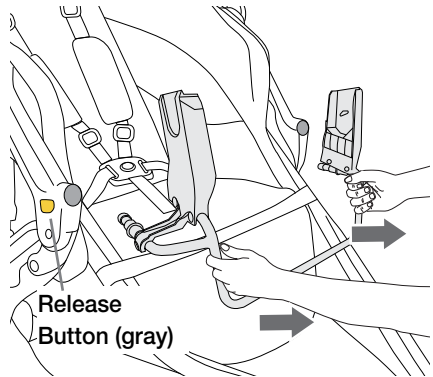

DETACHING REMOVABLE RECEIVERS FROM STROLLER

NOTE: This section instructs on how to detach the removable receivers from strollers that do not have built-in receivers.

- 1. Prepare Stroller**
 - (A) Set parking brake.
 - (B) Rotate canopy towards handlebar.

NOTE: For more information see stroller user guide

- 2. Remove receivers from stroller.**

Press yellow release button on the removable receiver and pull receiver away from the stroller frame. Repeat steps on opposite side.

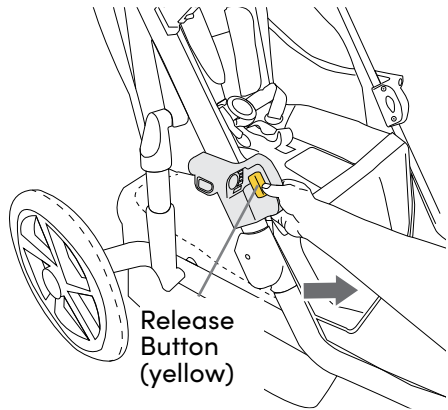

Care and Maintenance

CLEANING

- Use a sponge with a solution of mild soap and cold water (maximum temperature of 100° F / 38° C).
- Rinse thoroughly with clean water to remove soap, then air dry.
- Do not use detergent or abrasive cleansers.
- Do not pressure wash.

Stroller Accessories

BOB Gear® offers a complete line of accessories for your stroller. Visit our website bobgear.com for full details.

Warranty

This infant car seat adapter was manufactured by Britax Child Safety, Inc. ("Britax"). To the extent allowed by law, Britax warrants this product to the original retail purchaser as follows:

LIMITED WARRANTY

This product is warranted for one (1) year from the date of original purchase. Your exclusive remedy for this warranty is that Britax® will, at its option, provide repair or replacement components for this product. Britax® reserves the right to discontinue or change parts, models, or products, or to make substitutions. Proof of purchase is required for any warranty claims. Your exclusive remedy for this warranty is that Britax will, at its option, provide repair or replacement components to the original purchaser of this product. Britax reserves the right to discontinue or change fabrics, parts, models or products, or to make substitutions.

This warranty does not cover damages that arise from negligence, misuse or use not in accordance with the product instruction. Additionally, Britax products purchased from unauthorized retailers, online auction sites, or as second hand items are not covered under this warranty.

The use of non-Britax covers, inserts, toys, accessories, or tightening devices is not approved by Britax. Their use could cause this stroller to fail safety standards. Their use also may void the Britax warranty.

To make a claim under this warranty, you must contact Britax Consumer Services at 1-888-427-4829 or 1-704-409-1699, or write to us using the address on the back cover of this User Guide.

DISCLAIMER OF WARRANTIES

The following disclaimer shall apply to you to the maximum extent permitted by applicable law. THE LIMITED WARRANTY SET FORTH ABOVE IS THE EXCLUSIVE WARRANTY MADE BY BRITAX. ALL OTHER WARRANTIES, WHETHER EXPRESS, IMPLIED, OR STATUTORY, INCLUDING WITHOUT LIMITATION THE IMPLIED WARRANTIES OF MERCHANTABILITY AND FITNESS FOR A PARTICULAR PURPOSE, ARE DISCLAIMED. Some states do not allow certain exclusions or limitations on warranties, so the above may not apply to you. This warranty gives you specific legal rights, and you may have other rights, which vary from state to state. Neither Britax, nor the retailer selling this product, authorizes any person to create for it any other warranty, obligation, or liability in connection with this product.

LIMITATION OF DAMAGES

The following limitation of damages shall apply to you to the maximum extent permitted by applicable law. THE REMEDIES CONTAINED IN THE LIMITED WARRANTY SET FORTH ABOVE ARE THE EXCLUSIVE REMEDIES PROVIDED BY BRITAX. IN NO EVENT SHALL BRITAX BE LIABLE TO YOU FOR ANY INCIDENTAL, SPECIAL, PUNITIVE, EXEMPLARY, OR CONSEQUENTIAL DAMAGES ARISING OUT OF OR RELATING IN ANY WAY TO THE RELATIONSHIP BETWEEN YOU AND BRITAX (INCLUDING DISPUTES RELATED TO THE MARKETING OR SALE OF BRITAX PRODUCTS), ANY PROVISIONS IN THIS USER GUIDE, AND/OR YOUR PURCHASE OR USE OF ANY PRODUCTS DESIGNED, MANUFACTURED, DISTRIBUTED, MARKETED, OR SOLD BY BRITAX.

PLEASE COMPLETE AND MAIL THE OWNER REGISTRATION CARD WITHIN (30) DAYS OF PURCHASE

You may also register online at bobgear.com/registration.

Arbitration Agreement

MANDATORY ARBITRATION & CLASS ACTION WAIVER ("ARBITRATION AGREEMENT")

PLEASE READ THIS SECTION CAREFULLY BECAUSE IT AFFECTS YOUR LEGAL RIGHTS, REQUIRES YOU TO ARBITRATE DISPUTES, AND LIMITS THE MANNER IN WHICH YOU CAN SEEK RELIEF.

Arbitration is a process in which persons with a dispute waive their rights to file a lawsuit and proceed in court and to have a jury trial to resolve their disputes and, instead, agree to submit their disputes to a neutral third person (an "arbitrator") for a decision. Each party to the dispute has an opportunity to present some evidence to the arbitrator. Pre-arbitration discovery may be limited. Arbitration proceedings are private and less formal than court trials. The arbitrator will issue a final and binding decision resolving the dispute, which may be enforced as a court judgment. A court rarely overturns an arbitrator's decision.

YOU AND BRITAX AGREE THAT ANY DISPUTE BETWEEN US, WHETHER BASED IN CONTRACT, TORT, STATUTE OR OTHERWISE, SHALL BE RESOLVED IN BINDING INDIVIDUAL ARBITRATION. For purposes of this Arbitration Agreement, the word "dispute" and "disputes" are given the broadest possible meaning and include, without limitation, all claims, disputes, and/or controversies arising out of or relating in any way to the relationship between you and Britax (including disputes related to the marketing or sale of Britax products), any provisions in this User Guide or this Arbitration Agreement (including the interpretation and scope of this Arbitration Agreement and the arbitrability of any dispute), and/or your purchase or use of any products designed, manufactured, distributed, marketed, or sold by Britax. The Federal Arbitration Act ("FAA") and federal arbitration law apply to this Arbitration Agreement. Notwithstanding the foregoing, you and Britax each agree that you and Britax shall retain the rights to bring an individual suit in small claims court for disputes within the scope of such court's jurisdiction and/or to bring an individual suit in court to enjoin infringement or other misuse of intellectual property rights. In no way shall the foregoing sentence allow for an action to be brought on a class or collective basis.

YOU HAVE THE RIGHT TO OPT OUT OF THIS ARBITRATION AGREEMENT, BUT YOU MUST EXERCISE THIS RIGHT WITHIN THIRTY (30) DAYS OF YOUR PURCHASE OF A BRITAX PRODUCT. If you do not wish to be bound by this Arbitration Agreement, you must notify Britax by mailing or e-mailing a written opt-out notice, postmarked or electronically delivered within thirty (30) days of your purchase of a Britax product, to: ATTN: Legal Department, 4140 Pleasant Road, Fort Mill, South Carolina 29708. Your opt-out notice must include your full name, address and/or e-mail address, the model and serial numbers of the purchased product, a copy of your proof of purchase, and a statement that you intend to opt out of this Arbitration Agreement. If you do not opt out within thirty (30) days of your purchase, then this Arbitration Agreement will apply and you understand and agree that you are waiving your right to maintain other available resolution processes, such as a court action

or administrative proceeding, to resolve your dispute with Britax.

The arbitration will be conducted confidentially by a single arbitrator and administered by the American Arbitration Association (“AAA”) under its Consumer Arbitration Rules most recently in effect to the extent such rules and procedures do not contradict the express terms of this Arbitration Agreement. To learn more about the rules and how to begin an arbitration, you may call any AAA office or go to www.adr.org. If you demand arbitration, then at your request Britax will advance your portion of the expenses associated with the arbitration, including the filing, administrative, hearing and arbitrator’s fees (“Arbitration Fees”) to the extent such Arbitration Fees exceed \$200. If Britax demands arbitration, then at your request Britax will advance your portion of the Arbitration Fees. For claims of \$10,000 or less, you can choose whether you would like the arbitration carried out based only on documents submitted to the arbitrator or by a hearing in person or by telephone. The arbitration hearing will be conducted in the county of your residence, within 30 miles of such county, or in such place as shall be ordered by the arbitrator. Throughout the arbitration, each party shall bear his, her or its own attorneys’ fees and expenses, including any witness and expert witness fees. The arbitrator shall apply applicable substantive law consistent with the FAA, shall apply statutes of limitation, and shall honor claims of privilege recognized at law. The arbitrator shall decide, with or without a hearing, any motion that is substantially similar to a motion to dismiss for failure to state a claim or a motion for summary judgment. In conducting the arbitration proceeding, the arbitrator shall not apply any federal or state rules of civil procedure or evidence. The arbitrator shall not consolidate the claims of multiple parties unless you and Britax agree to do so. At the timely request of any party, the arbitrator shall provide a written explanation for the award. The arbitrator’s award may be filed with any court having jurisdiction.

THIS ARBITRATION AGREEMENT DOES NOT ALLOW CLASS OR COLLECTIVE ARBITRATIONS EVEN IF THE AAA RULES OR PROCEDURES WOULD. IN OTHER WORDS, YOU AND BRITAX EACH AGREE THAT ALL DISPUTES SHALL BE ARBITRATED ON AN INDIVIDUAL BASIS AND WAIVE ANY RIGHT TO PROCEED IN A CLASS, CONSOLIDATED, OR REPRESENTATIVE FASHION. THE ARBITRATOR MAY AWARD MONEY OR INJUNCTIVE RELIEF ONLY IN FAVOR OF THE INDIVIDUAL PARTY SEEKING RELIEF AND ONLY TO THE EXTENT NECESSARY TO PROVIDE RELIEF WARRANTED BY THAT PARTY’S INDIVIDUAL CLAIM. NO CLASS, REPRESENTATIVE OR PRIVATE ATTORNEY GENERAL OR GENERAL INJUNCTIVE RELIEF THEORIES OF LIABILITY OR PRAYERS FOR RELIEF MAY BE MAINTAINED IN ANY ARBITRATION CONDUCTED PURSUANT TO THIS ARBITRATION AGREEMENT.

If the foregoing class action waiver and prohibition against class arbitration is determined to be invalid or unenforceable for any reason, then this entire Arbitration Agreement shall be void. If any portion of this Arbitration Agreement other than the class action waiver and prohibition against class arbitration is deemed to be invalid or unenforceable for any reason, it shall not invalidate the remaining portions of this Arbitration Agreement. If for any reason a dispute proceeds in court rather than in arbitration, you and Britax each waive any right to a jury trial.





BIENVENUE CHEZ BOB® GEAR

BOB Gear® par Britax recommande que vous inscrivez votre poussette à **bobgear.com/registration**. Cela nous permettra de vous contacter directement s'il y a des rappels de produits.

Pour des mises à jour de ce manuel, de la garantie ou autres notifications de nouveaux produits, veuillez visiter **bobgear.com** périodiquement et avant de faire des changements approuvés ou d'ajouter des équipements approuvés pour votre poussette.



BOB Gear® by Britax © 2022 Britax Child Safety, Inc.

 (888) 427-4829  (704) 409-1699  bobgear.com

 4140 Pleasant Rd, Fort Mill, South Carolina 29708

All rights reserved. Printed in China. This product and its components are subject to change without notice.

Tous droits réservés. Imprimé en Chine. Ce produit et ses composants peuvent changer sans préavis.

Reservados todos los derechos. Impreso en China. Este producto y sus componentes están sujetos a cambios sin previo aviso.